

Table-Top Universal Testing Instruments

# EZ Test



Compact solutions for performing tests

# EZ Test

Table-Top Universal Testing Instruments



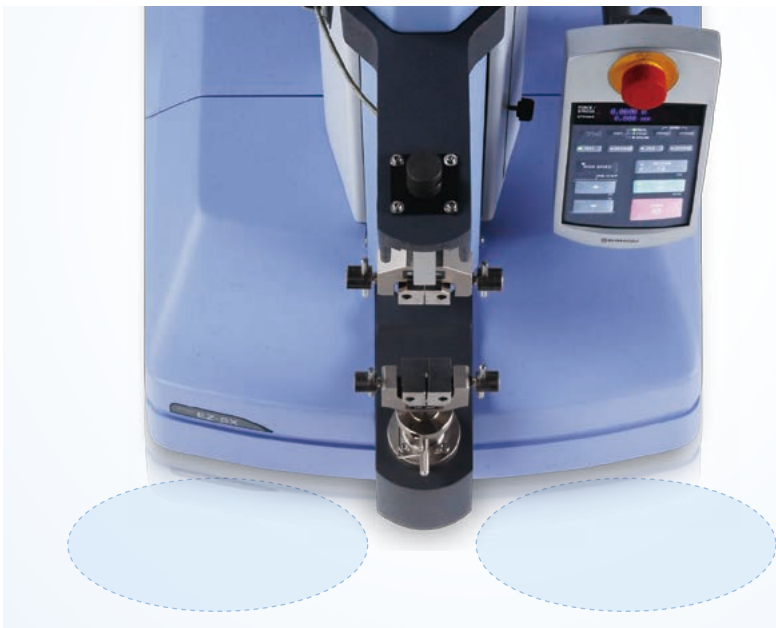

## Lightweight and Compact

The compact size fits easily on table tops. An "open table" design provides open access from both sides of the table to ensure a large work space.

## Convenient to Use

The height of the device has been lowered significantly. This makes it easier to exchange jigs and samples, and to perform a wide variety of operations.



## Adjustable Control Panel

An adjustable manual controller allows the user to set the crosshead positioning and start or stop testing. The position and angle of the control panel can be adjusted to match the user's posture.

## High-Precision Testing System

High-precision test force measurements are guaranteed with a load cell of up to 5 kN capacity.

The system uses a high-precision load cell that guarantees accuracy to within  $\pm 0.5\%$  of the indicated value (high-precision type) over a wide range, from 1/500 to 1/1 of the rated capacity. This ensures highly reliable evaluation tests over a wide range of loads.

### Compliance

JIS B7721 Class 1  
 ISO 7500-1 Class 1  
 EN 10002-2 Grade 1  
 ASTM E4

Note: Shimadzu recommends inspection at an installation site that meets the requirements specified in these standards.



## A Range of Models to Meet a Variety of Needs

With 3 tester models and 12 types of load cells available, the most suitable system can be selected from 32 possible combinations. A high-speed model with a return speed of 3000 mm/min significantly shortens test cycle times. In addition, power consumption has been reduced by over 55% compared to previous models.

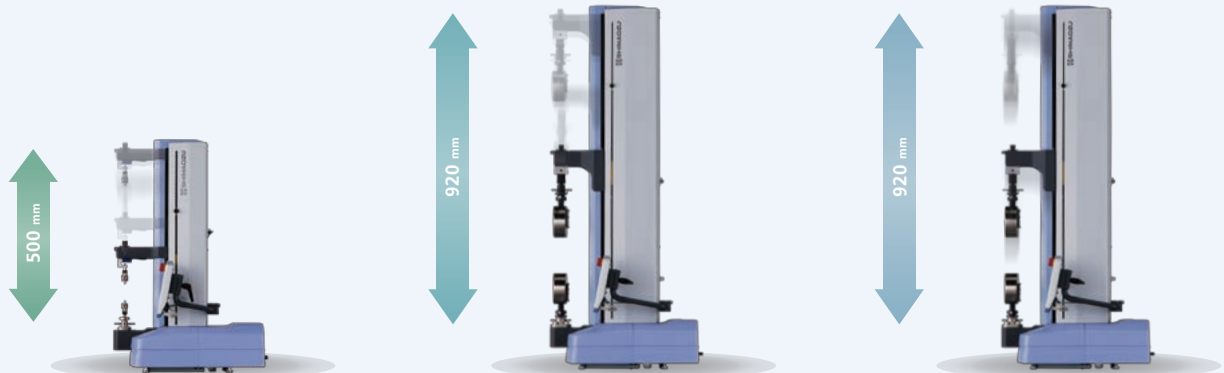

**EZ-SX Short Model**

This is ideal for testing foodstuffs, pharmaceuticals and their packaging, and electrical or electronic parts. With a wide range of testing speeds, it can accommodate all sorts of evaluation testing applications.

Max. Capacity	<b>500 N</b>
Max. Stroke	<b>500 mm</b>
Test Speed Range	<b>0.001 to 1000 mm/min</b>
Max. Return Speed	<b>1500 mm/min</b>

**EZ-LX Long-Stroke Model**

With a 5 kN maximum capacity, this is perfect for the tensile testing and bend testing of plastics. The 920 mm stroke capacity also makes it perfect for testing rubber, film, and other materials with large elongation.

Max. Capacity	<b>5 kN</b>
Max. Stroke	<b>920 mm</b>
Test Speed Range	<b>0.001 to 1000 mm/min</b>
Max. Return Speed	<b>1500 mm/min</b>

**EZ-LX HS Long-Stroke and High-Speed Model**

The long stroke improves productivity. The 3000 mm/min return speed significantly reduces the wait time between tests, even for tests with large displacements.

Max. Capacity	<b>2 kN</b>
Max. Stroke	<b>920 mm</b>
Test Speed Range	<b>0.001 to 2000 mm/min</b>
Max. Return Speed	<b>3000 mm/min</b>

## Suitable for Product Tests in Diverse Fields

Physical evaluation testing is now required in more fields than ever before. EZ Test offers an ample selection of specialized jigs and features to support a wide variety of customer requirements.



# Evaluating Food Textures

## Compression Test on Bread

25 mm thick bread was compression tested using a 36 mm diameter cylindrical jig. Stress was measured at 40% deformation at a test speed of 100 mm/min, in accordance with standard AACC test methods.

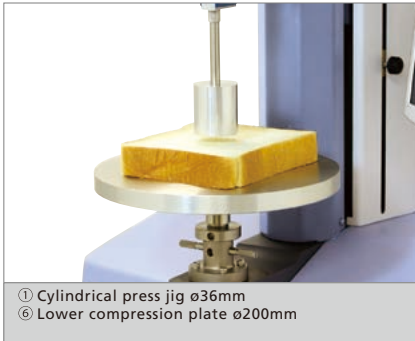

## Surface Hardness Test on Apple

Piercing test jigs are used for piercing and penetration tests. They make it possible to evaluate the surface hardness (yield point) of skins, coatings etc. on samples such as vegetables, fruits, and jelly beans.

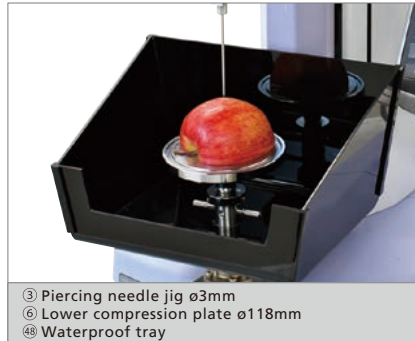

## Piercing Test on Jam

Multi-piercing jigs make it possible to evaluate the hardness or cohesiveness of samples containing food pieces (a large number of small pieces with varying shape) or air bubbles dispersed throughout the sample, such as jam with pieces of fruit, ice cream with cookie pieces, or vegetables. The jig enables evaluation of average properties over multiple points, to minimize variation due to point of entry.

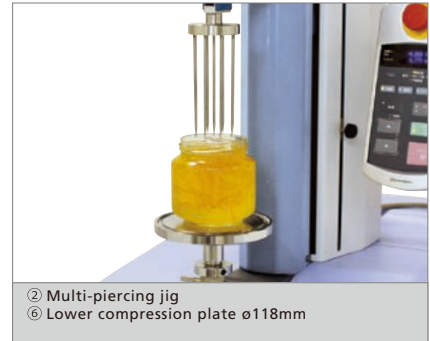

## Shear Test on Potato Croquette

This jig is designed to simulate the shape of various types of teeth. It is used to test the compression, shear, crush, and other characteristics of food specimens. It enables comparative testing of crispiness, brittleness, chewiness, and other characteristics.



## Shear Test on Butter

This wire cutter jig uses a 0.3 mm diameter stainless steel wire for shear testing of samples such as butter, margarine, cheese, and noodles. It makes it possible to evaluate the surface and internal firmness of samples.



## Hardness Test on Butter

Conical press jigs are used for compression or piercing testing for samples that exhibit thermal plasticity, such as butter, margarine, and bar soap. They are used to evaluate characteristics such as the hardness and spreadability of samples.



## Evaluation Tests of Nursing Care Foods

This jig set is used to test foods intended for people with difficulty swallowing, based on the notification issued by the Japanese Consumer Affairs Agency, or to test "universal design foods" advocated by the Japan Care Food Conference. It is designed to accurately measure even small test force profiles obtained from soft foods.

A 40 mm diameter container is filled to a depth of 15 mm with the sample, which is then compression tested with a 20 mm diameter plunger.

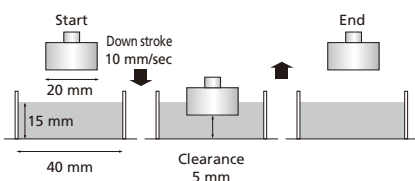

## Tensile and Shear Tests on Noodles

This jig is used to tensile-test various types of noodles or pasta, such as udon (thick wheat noodles), soba (buckwheat noodles), or spaghetti. Two jig types can be selected, where one secures the noodles by pinching them between two surfaces and the other secures the noodles by wrapping them and using the tightening force of the noodle itself. It allows evaluation of characteristics such as the tensile strength and elongation of noodles.

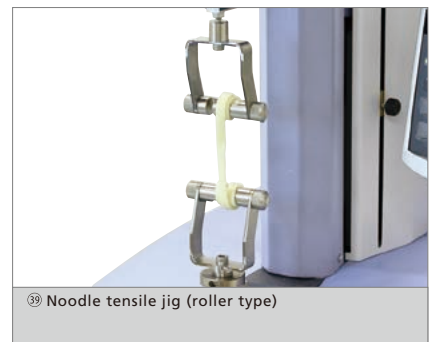

## Jig Platform

The upper plate portion can be replaced with various jig attachments such as a tray for catching extruded or spilled samples or a waterproof tray. Without any attachments, the platform can be used as a table.



⑩ Jig platform

## Shear test on Asparagus

The Volodkevich bite jig simulates a human incisor tooth biting through a sample. This jig is used to measure the softness or hardness of meat, the shear force required to bite through asparagus, celery or other fibrous fruits or vegetables, or for piercing testing.



⑪ Volodkevich bite jig  
⑩ Jig platform  
⑫ Upper jig

## Viscoelasticity Test on Gelatin

This apparatus makes it possible to perform gelatin tests (JIS K 6503) or other viscosity tests of gelatinous samples. A 85 mm tall glass container with a 60 mm internal diameter and a 0.5 inch (12.7 mm) compression plunger (cylindrical jig) are used.



⑬ Gelatinous sample strength evaluation set  
⑩ Jig platform  
⑭ Upper jig

## Shear Test on Sausage

This jig enables shear tests that involve cutting with a blade. In addition to V-cuts for Werner Platzer tests, it allows the user to substitute blades with other edge profiles. It is used to evaluate the shearing of foods such as meats, sausages, cheese, vegetables, and snack bars.



⑮ Blade shear jig (60° V-Cut)  
⑩ Jig platform

## Compression Shear Test on Cereal

The Kramer shear cell is a specialized jig that uses multiple blades to perform compression, shear, and extrusion tests. It enables repeatable testing of cereals, beans, sauces containing food pieces, and other samples.



⑯ Kramer shear cell, 5-blade type  
⑩ Jig platform

## Compression Shear Test on Beans

This specialized mini-Kramer shear cell allows testing of smaller sample quantities. Just as with the standard size jig, this is used to evaluate samples by shearing, compressing, and extruding the samples.



⑰ Mini Kramer shear cell / Ottawa cell  
⑩ Jig platform

## Spreadability Test on Margarine

This jig set is used to evaluate how easy it is to spread samples that are normally spread into a thin layer, such as margarine or car wax. The jig set measures the test force required to spread a sample between the upper and lower jigs.



⑱ Spreading jig  
⑩ Jig platform  
⑲ Upper jig

## Three-Point Bending Test on Cookies

This setup makes it possible to evaluate the breaking strength or brittleness of samples by performing a bending test. It is ideal for testing the three-point bending strength of samples such as biscuits or chocolate bars. Different types of upper punches or supports can be selected based on the sample.



⑲ Three-point bending test jig (R2.5mm)  
⑩ Jig platform

## Break Strength Test on Potato Chips

This jig is used for penetration testing of items such as snack foods and potato chips. The test force required to break samples can be measured and used as an index for evaluating brittleness or crispiness.

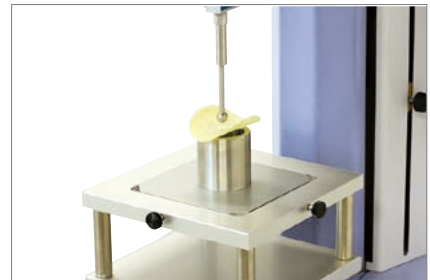

⑲ Break test jig set  
⑩ Jig platform

### Crush Test on Fruit

Ottawa cells are specialized jigs that compress samples and measure the compression or extrusion force required to extrude the sample through a slit in the bottom. They are used to evaluate samples such as vegetables, fruits, beans, and cereals.



③⑥ Ottawa cell set  
③ Jig platform

### Extrusion Test on Liquid

This jig makes it possible to measure the test force required to extrude samples through a hole. The extrusion hole size can be changed based on the concentration and viscosity of the sample. It is used to evaluate liquids such as sauces, pastes, and gels.



③⑦ Tubing test jig  
③ Jig platform

### Viscoelasticity Test on Liquid

This setup is used to evaluate the viscosity of viscous samples, such as yoghurt, cream, sauces, ground fruit or vegetables, or paint. Different compression plates are used based on the viscosity, food piece content or size of samples.



③⑧ Overflow test jig set  
③ Jig platform  
③ Upper jig

## Evaluating Pharmaceuticals, Medical Devices, and Household Goods

### Compression and Splitting Tests on Pills

By compression testing, pills, hard candies, and similar items can be evaluated in terms of hardness, powder molding, and surface coating characteristics. The type of compression plate and spherical press jig can be selected based on the tablet size.

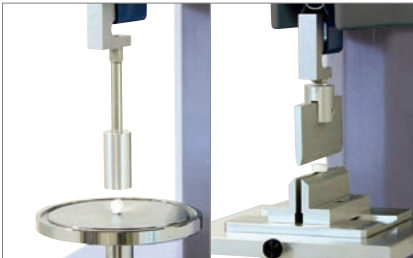

Compression tests ① Cylindrical press jig  $\phi 20$   
⑥ Lower compression plate  $\phi 118$   
Splitting Tests ② Three-point bending test jig R0.1  
③ Jig platform

### Press-Dispense Test on Tablets

This setup used to evaluate the force necessary to press tablets or capsules out of press-through packaging (PTP). Various PTP shapes can be tried out by changing the adapter.



④⑤ Tablet press-dispense jig set  
③ Jig platform  
③ Upper jig

### Injectability Test on Syringe Needle

An injectability test measures the test force required to pierce a vial cap, film, or other material with a syringe needle. The insertion of the needle into the syringe is repeatable because the length to be inserted is specified in regulations.

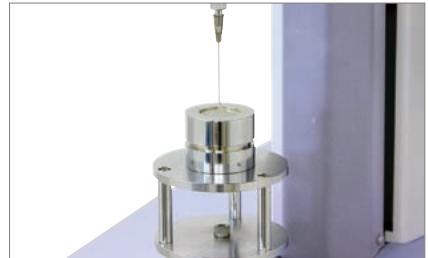

④③ Syringe needle attachment jig  
④① Boil-in-bag piercing stand  
③ Upper jig  
③ Lower jig

### Hardness Test on Lipstick

This jig is used to evaluate the hardness of lipstick. The lipstick is secured in a horizontal position and pressure is applied in a vertical direction for evaluation.



②⑤ Lipstick test jig set  
③ Lower jig

### Testing Adhesive Bandages

The physical properties of adhesive bandages are evaluated by testing the force required to peel open the bandage packaging, its adhesiveness, tensile strength etc.



⑦ 500 N tensile jig

### Extrusion Test on Syringe

This jig makes it possible to measure the test force required to extrude samples from a syringe. Syringes of up to 30 mm diameter can be accommodated by changing the adapter.



④② Syringe extrusion test jig

# Evaluating Plastics and Rubbers

## Tensile Test on Rubber Dumbbells

In this example, a rubber dumbbell was tensile-tested using pneumatic flat grips. These grips are able to use air pressure to grip specimens with a constant force, which makes it possible to securely grip rubber and other specimens that decrease in thickness as tension is applied. Using an DSES-1000 extensometer allows elongation to be accurately measured all the way up to the breaking point.

DSES-1000 is compliant with various rubber tensile testing standards.

JIS K6251:2010	JIS K6272:2003
ISO 37:201	ISO5893:2002
ASTMD412-06a	GB/T528-2009



- 1 kN screw-type flat grips
- Long travel extensometer for soft specimens DSES-1000

## Tensile Test on Film

In this example, film was tensile-tested using grips intended for foil. These grips have a special grip face that reduces the breakage of film and copper foil samples at the chuck during testing. When used in combination with a TRViewX non-contact digital video extensometer, elongation and lateral displacement can be accurately measured, which means the modulus of elasticity can also be calculated.



- 1 kN grips for foil
- Video-type non-contact extensometer TRView X series

## Tensile Test on Plastic

In this example, a tensile test was performed on a plastic sample using 5 kN non-shift wedge-type grips. The grip faces move horizontally to tighten their grip on the sample without moving in the vertical direction. This makes it easy to set the distance between grips and minimize any vertical test forces acting on the specimen during the initial tightening. When a tensile test force is applied, it causes the wedges to hold the sample securely. Furthermore, the user can comply with ISO standards by using an SSG-H strain-gauge-type one-touch extensometer.



- 5kN manual non-shift wedge-type grips
- Strain-gauge-type one-touch extensometer SSG-H series

## Bending Test on Plastic

In this example, a 3-point bending test jig is used to test the bending of a plastic sample. This 3-point bending test jig for plastics was designed to meet JIS, ISO, and ASTM standards and allows testing for any thickness within the scope of the standards by changing the support set.

It also includes a jig for setting the distance between supports and checking whether the punch and supports are parallel, which makes it easy to adjust the test jig.

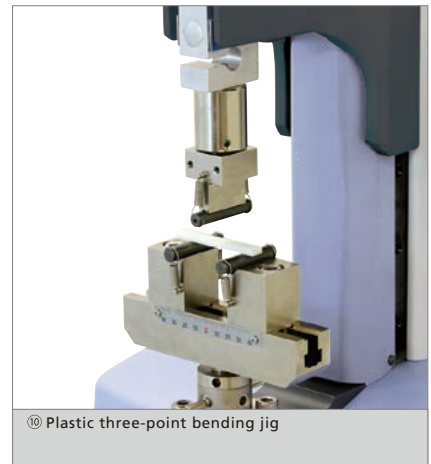

- Plastic three-point bending jig



### Piercing Test on Film

This jig makes it possible to measure the piercing strength needed to puncture various film materials, such as those used in retort (boil-in-bag) pouches. Test samples are cut into circles about 20 mm in diameter for testing.

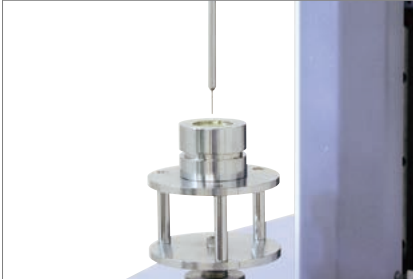

⑭ Boil-in-bag piercing stand  
Ⓢ Upper jig  
Ⓢ Lower jig

### Tensile Test on Fibers

This jig includes capstans to grip thread, cords, and other narrow fibrous samples so that an initial tension force can be applied and breakage can be prevented at the chuck. Samples are gripped pneumatically.



• 1 kN pneumatic capstan type grips for yarn  
Ⓢ Adapter for AGS series jig  $\phi$ 16

### Friction Modulus Measurement

This test device measures the friction between plastic films or between plastics and other materials. Both static and dynamic frictional forces can be measured seamlessly.

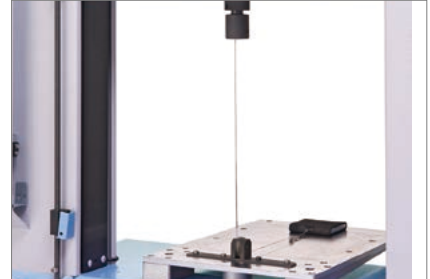

⑭ Friction modulus measurement jig

### Peeling Test on Adhesive Tape

The sample table slides in sync with the upper grip movement to maintain a 90° peeling angle. The peeling test jig is compliant with JIS Z0237 and JIS Z1528.

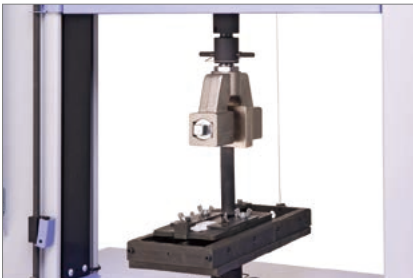

• Adhesive tape peeling test device

### Tensile Test on O-ring

The O-ring is hooked onto rollers, which rotate during tensile testing. Tests conforming to JIS K6251, JIS K7312, ISO 37, and ASTM D412 standards can be performed.



• 1 kN roller-type grips

### Compression Test on Springs

The compression strength of springs can be measured by compressing the spring between upper and lower compression plates. The lower compression plate is designed so that fine adjustments can be made to the parallelism of the plates.



⑬ Spring test jigs

## Evaluating Electrical and Electronic Parts

### 45° Peel Test on Surface Mounted Devices

This test jig set is used to measure the peel strength of electronic parts, particularly the pins on IC chips.



⑫ Peeling test jig set

### Shear Test on Electronic Components

This test jig set is used to press vertically on components to measure their shear strength.



⑪ IC pin test jig

### Cyclic Bending Test on Printed Circuit Board

This test jig is for cyclic bending tests of printed circuit boards. It allows observation of fluctuations in resistance in response to cyclic loads, as well as other properties. It enables repeatable tests of the thermal expansion and contraction of solder.

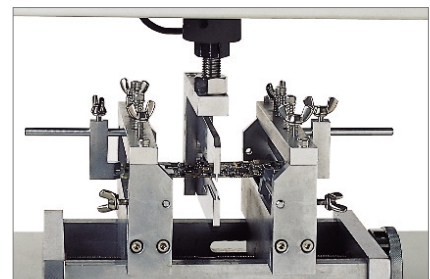

• Printed circuit board cyclic bending test jig

# Supported by a Refined Operation System



By registering frequently-used parameters in a Quick Parameter List, tests can be started with a single step.

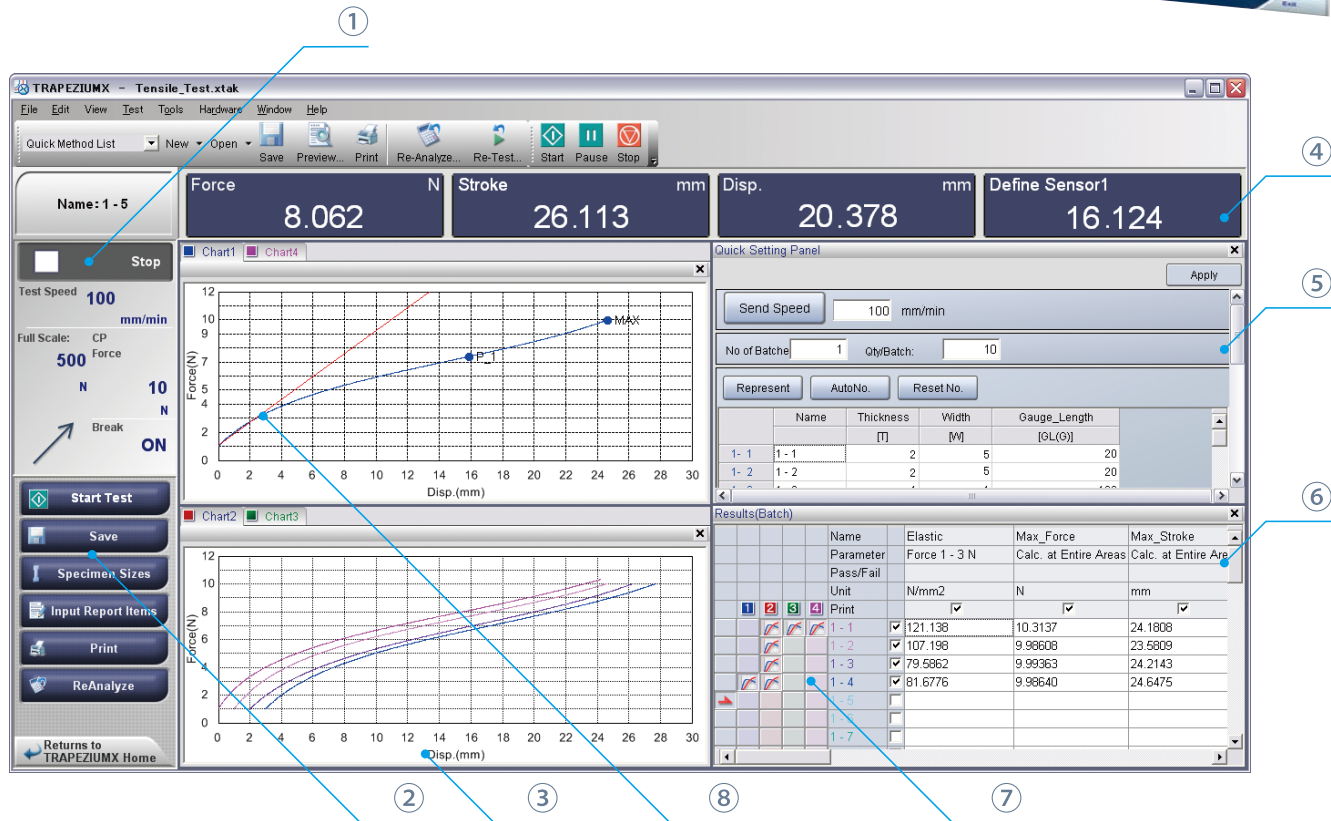

**1 Test Method & Status Panel**

Confirm testing conditions and the test status from the main window.

**2 Advanced Navigation System with a Learning Function**

The Navigation Bar shows only the functions required for selected situations. In addition, the "Learning Function" records user actions for each situation and adds frequently-used parameters as navigation buttons. This improves work efficiency by matching functions to a user's operational style.

**3 Multiple Graph Function**

Up to four graphs can be displayed at once. The settings for both axes can be edited. A maximum of 50 graphs can be overlaid, and the user can select points with the mouse. This allows the user to examine each test in more detail.

**4 Real-time Data Display Panel**

Displays the test force, stroke (strain), extensometer or strain gauge value and other input values, all in one window. Optional calculated values can be displayed at the same time, so that data can be checked more smoothly.

**5 Quick Panel**

The speed, dimensions and report information can be entered directly from the testing screen.

**6 Results Panel**

This panel allows the user to change a variety of settings for repeat tests and batch testing. For example, samples can be inserted in any order, or added only to a specific batch.

**7 Checkboxes to Select Curves**

The user can select which data appears in each graph window, making it easy to compare SS-curves or graphs with a user-specified axis.

**8 Various Data Processing Functions**

Many data processing functions are available e.g. for calculating modulus of elasticity. Settings can be applied by simply pressing the buttons above the figure.

## Single

This software is specialized for standard testing of plastics, rubber, fibers, textiles, film, paper, electronic components, and other items that are tested with one-dimensional movement.

Tensile tests, compression tests, 3- and 4-point bending tests, peel tests, and more



TRAPEZIUM LITE X is software based on the Single module of TRAPEZIUM X software. Linking the testing machine to a computer significantly improves the efficiency of routine testing. It is particularly useful for quality control testing, which involves performing tests frequently using a given set of test parameters.

\* The Texture, Cycle and Control software modules cannot be added to Trapezium Lite X.

## Texture

This software is ideal for checking food textures, or evaluating the quality or physical properties of pharmaceuticals, cosmetics etc. It allows the user to define control patterns in order to create data processing rules specialized for foods, for example for finding hardness, brittleness, and energy.

Compression tests (piercing, penetration, and break analysis tests), tensile tests, texture tests (two-bite method), indentation tests, gel strength tests, shear/cutting tests, adhesiveness tests, hardness tests, and more

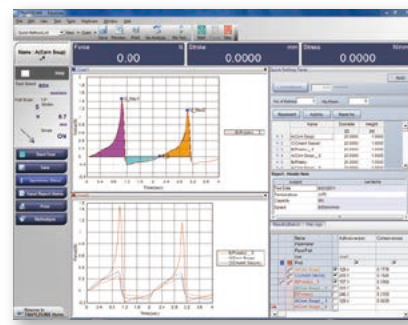
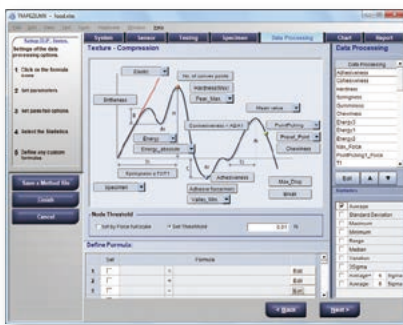

## Cycle

This software enables endurance tests and other tests that involve repetitive vertical movement. It is especially well suited to testing individual parts of electronic devices or testing the endurance of printed circuit boards and connectors.

## Control

This software allows the user to freely specify the order of a testing machine's movements. It makes it possible to configure complicated combinations of tensile, compression, and holding steps.

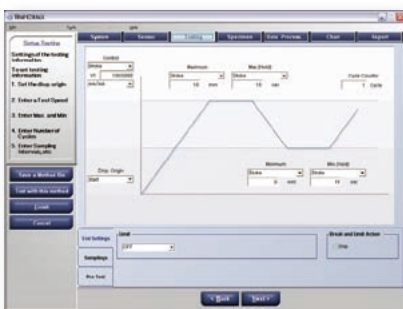

# EZ Test Specifications

Name		EZ Test		
		EZ-SX	EZ-LX	EZ-LX HS
Tester Load Capacity <sup>(note 1)</sup>		Max. 500 N	Max. 5 kN	Max. 2 kN
		The load cell type can be selected from 9 types: 1 N, 2 N, 5 N, 10 N, 20 N, 50 N, 100 N, 200 N, or 500 N.	The load cell type can be selected from 12 types: 1 N, 2 N, 5 N, 10 N, 20 N, 50 N, 100 N, 200 N, 500 N, 1 kN, 2 kN or 5 kN. (Up to 2 kN for EZ-LX HS)	
Load Method		High-precision constant-speed strain measurement using backlash-free ball screw drive		
Test Force Measurement	High-Precision Type <sup>(note 2)</sup>	±0.5% of indicated value (within 1/500 to 1/1 of load cell rated capacity)		
	Standard-Precision Type <sup>(note 2)</sup>	Conforms to JIS B 7721 class 0.5, ISO 7500-1 class 0.5, EN 10002-2 grade 0.5, and ASTM E4.		
	Range	±1% of indicated value (within 1/500 to 1/1 of load cell rated capacity)		
	Test Force Calibration	Conforms to JIS B 7721 class 1, ISO 7500-1 class 1, EN 10002-2 grade 1, and ASTM E4.		
Crosshead Speed Range		0.001 to 1000 mm/min		0.001 to 2000 mm/min
Maximum Return Speed		1500 mm/min		3000 mm/min
Crosshead Speed Accuracy <sup>(note 3)</sup>		Within ±0.1% of test speed		
Crosshead Speed and Allowable Test Force		Up to the capacity of the load cell at all speeds		
Distance Between Crosshead and Jig Mounting Surface		500 mm	920 mm	
Maximum Grip Space		395 mm (500 N max. load cell + tensile jig)	700 mm (5 kN load cell + 5 kN screw type flat grips)	
			755 mm (1 kN load cell + 1 kN screw type flat grips)	
			860 mm (500 N max. load cell + tensile jig)	
Depth of Test Space		100 mm (table section)		
Crosshead Position Detection	Measurement & Display	Optical encoder measurement, digital display (display resolution: 1 µm)		
	Accuracy	±0.1% of indicated value or ±0.01 mm, whichever is greater		
Crosshead Control		Single test control (single-direction tension or compression test), cycle test control (repetitive tension or compression test)		
Sampling Speed		1 ms max. (TRAPEZIUM X/TRAPEZIUM LITE X is needed for this function)		
Standard Functions Included		Constant test force (creep) control <sup>(note 4)</sup>		
		Auto-stop and auto-return functions when specimen fracture is detected (crosshead auto home-position return)		
		Test condition file function, adjustable crosshead speed function		
		Display function: Actual test force display or stress display (set by user)		
		Crosshead displacement display in mm or %/GL (set by user)		
		Peak point test force and stroke		
		Test force and displacement analog output: 0 V to 5 V DC full scale, respectively (for external recorder)		
		USB interface		
		Manual crosshead position fine adjustment		
		Adjustable controller		
Dimensions and Weight		W400 × D530 × H885 mm, approx. 33 kg	W400 × D530 × H1315 mm, approx. 55 kg	
Input Power Supply Voltage <sup>(note 5)</sup>		Single phase, 100 V to 150 V AC, 50/60 Hz, or 200V to 230V AC, 50/60 Hz		
Power Capacity		700 VA	850 VA	
Installation Environmental Conditions		Temperature: 5°C to 40°C, Humidity: 20% to 80% (no condensation)		
		Power voltage fluctuation: within ±10%, Vibration: 10 Hz max., Amplitude: 5 µm max.		

Note 1: When the load cell capacity is smaller than the tester load capacity, the former is the maximum test force.

Note 2: Shimadzu recommends inspection at an installation site that meets the requirements specified in these standards.

Note 3: Crosshead speed accuracy is calculated from the crosshead displacement within a prescribed time at a constant speed between 0.5 mm/min and 500 mm/min.

Note 4: The test force is kept constant at 70% or less of the tester load capacity, for up to 12 hours.

Note 5: Ground resistance should be 100 Ω or less.

# Options

## Tester Options



**Jog Controller**  
346-55922-01  
The jog dial is provided to allow finger-tip operation of the crosshead position.



**Safety Cover**  
EZ-SX: 346-57107-01  
EZ-LX: 346-57107-02  
This is used to prevent injury when sample fragments are scattered due to fracture.



**Control I/O Expansion Box**  
346-55920-01  
Increases the number of control I/O ports to four. Multiple optional accessories can be simultaneously connected to the control I/O ports.

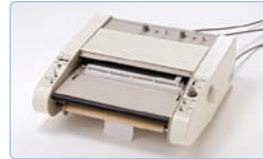

**Analog Recorder**  
X-T type: 346-59210-01  
Plots test force - time curves.  
X-YT type: 346-51736-01  
Plots test force - time curves and test force - stroke curves.



**Sensor I/O Expansion Box**  
346-55920-02  
Increases the number of tester sensor I/O ports to two. Multiple optional accessories can be simultaneously connected to the sensor I/O ports. BNC cables can be connected to the analog I/O ports.



**Power Cable**  
For EU (VDE standard)  
348-34063-03  
For China (GB standard)  
348-34063-02  
For Japan and North America (UL, CSA, PSE standards)  
348-34063-01 is provided as standard.

A variety of other options are also available. For details, refer to the separate catalog "Optional Accessories for Autograph".

## Additional Load Cell Kits

Select a load cell kit if load cells are to be added to the tester unit kit. The additional load cell kit comprises a cell set (load cell and calibration cable), cell bolt (if required), and upper joint jig (if required).

LOAD CELL SET (Load cell, calibration cable and calibration)

CLASS	EZ-TEST	EZ-LX											
		EZ-LX HS											
		EZ-SX											
		5 kN	2 kN	1 kN	500 N	200 N	100 N	50 N	20 N	10 N	5 N	2 N	1 N
1	346-55939-XX	10	14	9	13	12	07	06	05	04	03	02	01
0.5	346-55942-XX	10	14	9	13	12	07	06	05	04	03	02	01

## Thermostatic Chamber

Allows testing within an ambient temperature range of -70°C to 250°C. Thermostatic chambers are available only for EZ-L type testers.

The chambers are special-order items. For details, please make a separate inquiry.



## Installation Space

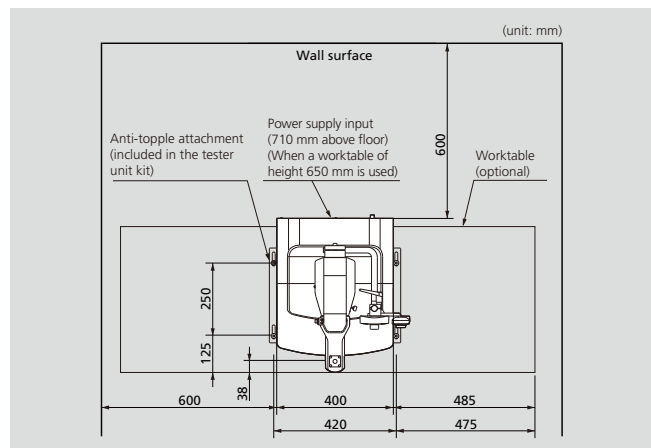

Note: A similar installation space is required for both EZ-SX and EZ-LX.

## Other Options

Description	P/N	Remarks
Worktable	340-48580-02	Worktable for EZ Test
Anti-topple attachment for EZ-SX/EZ-LX	346-55037-12	Secures the tester unit to the worktable.
	346-55037-11	Secures the tester unit to the worktable, or the worktable to the floor.

# Jig Part Number List

\*1 : ⊙ An upper adapter jig is necessary \*2 : ⊙ A lower adapter jig is necessary \*3 : ⊙ A jig platform is necessary

## Probes

### ① Indentation elasticity test jig / Cylindrical press jig

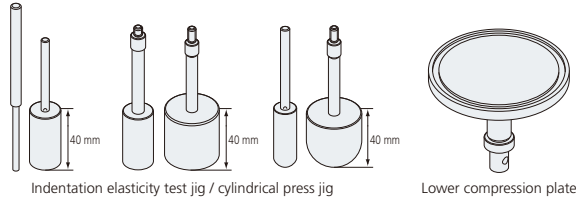

Indentation elasticity test jig set		346-52284-01
Item list	Indentation elasticity test jig dia. 3 mm	346-51687-01
	Indentation elasticity test jig dia. 5 mm	346-51687-02
	Lower compression plate dia. 118 mm	346-51687-12

### ③ Piercing needle jig / Indentation test jig

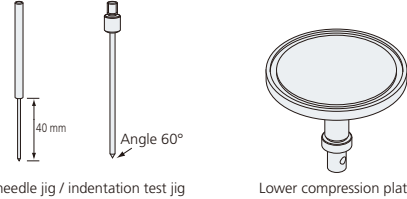

Indentation elasticity test jig set		346-52283-01
Item list	Indentation elasticity test jig dia. 3 mm	346-51813-01
	Indentation elasticity test jig dia. 5 mm	346-51813-02
	Lower compression plate dia. 118 mm	346-51687-12

### List of Part Numbers by Size, Material and Capacity

Diameter (mm)	Material	Capacity	P/N
ø1	SS	5 N	346-38590-02
ø2	SS	20 N	348-38504-02
ø3	SS	50 N	348-38504-03
	Steel+Plating	50 N	346-51687-01
ø4	SS	200 N	348-38504-04
	Steel+Plating	500 N	346-51687-02
ø5	SS	500 N	348-38505
	Steel+Plating	500 N	346-51687-02
ø6	SS	500 N	348-38506-01
	SS	500 N	348-38506-02
ø8	SS	500 N	348-38506-03
ø9	SS	500 N	348-38506-04
ø10	SS	500 N	348-38506-05
	acrylic	100 N	346-57801-04
ø11.3 (cross section: 1 cm <sup>2</sup> )	SS	100 N	346-57801-03
	acrylic	100 N	346-57801-07
ø15	AL	100 N	346-57801-08
	acrylic	100 N	346-57801-09
ø20	AL	100 N	346-57801-01
	acrylic	100 N	346-57801-05
ø25	AL	500 N	346-57802-01
	acrylic	200 N	346-57802-11
ø30	AL	500 N	346-57802-20
	acrylic	200 N	346-57802-21
ø35	AL	500 N	346-57802-02
	acrylic	200 N	346-57802-12
ø36	AL	500 N	346-57802-03 (AOAC, bread compression test)
	AL	500 N	346-57802-04
ø40	acrylic	200 N	346-57802-13
	AL	500 N	346-57802-05
ø45	acrylic	200 N	346-57802-14
	AL	500 N	346-57802-06
ø50	acrylic	200 N	346-57802-15
	SS	500 N	348-38506-06
ø6.4 (ø1/4")	AL	100 N	346-57801-02
	acrylic	100 N	346-57801-06 (JIS/ISO, gelatin test)
ø25.4 (ø1")	AL	500 N	346-57802-07
	acrylic	200 N	346-57802-16
ø38.1 (ø3/2")	AL	500 N	346-57802-10
	acrylic	200 N	346-57802-19
ø50.8 mm (ø2")	AL	500 N	346-57802-08
	acrylic	200 N	346-57802-17
ø1/2" (round tipped)	SS	500 N	346-57803-01
	acrylic	500 N	346-57803-11
ø1" (round tipped)	SS	100 N	346-57803-02
	acrylic	100 N	346-57803-12

### ② Multi-piercing jig

Capacity : 500 N  
Each Prove : ø3 mm, Angle 15° (9 Proves)

Multi-piercing jig	346-57804
--------------------	-----------

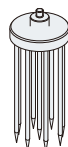

### List of Part Numbers by Size, Material and Capacity

Diameter (mm)	Material	Capacity	P/N
ø1 (60° taper)	SS	5 N	346-57829-01 *1
ø2 (60° taper)	SS	20 N	348-38503-02 *1
	SS	50 N	348-38503-03 *1
ø3 (60° taper)	SS	50 N	348-38502-01
	SS	50 N	348-38502-01
ø4 (60° taper)	SS	200 N	348-38503-04 *1
	SS	200 N	348-38502-02
ø5 (60° taper)	SS	500 N	348-38503-05 *1
	SS	500 N	348-38502-03

### ④ Spherical press jig / Viscosity test jig

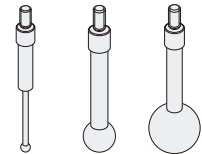

### List of Part Numbers by Size and Material

Diameter (mm)	Material	Capacity	P/N
ø3	SS	100 N	348-38511-01
ø4	SS	100 N	348-38511-02
ø5	SS	100 N	348-38511-03
ø6	SS	100 N	348-38511-04
ø7	SS	500 N	348-38511-05
ø8	SS	500 N	348-38511-06
ø9	SS	500 N	348-38511-07
ø10	SS	500 N	348-38511-08
ø15	SS	500 N	348-38512-01
ø20	SS	500 N	348-38512-02
ø25	SS	500 N	348-38512-03
ø3.2 (ø1/8")	SS	20 N	348-38511-09
ø6.4 (ø1/4")	SS	100 N	348-38511-10
ø12.7 (ø1/2")	SS	500 N	348-38511-11
ø19.1 (ø3/4")	SS	500 N	348-38512-04
	acrylic	500 N	348-38555-01
ø25.4 (ø1")	SS	500 N	348-38512-05
	acrylic	500 N	348-38555-02

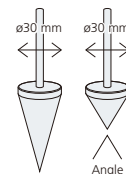

### ⑤ Conical press jigs

Jig Diameter : ø30 mm

### List of Part Numbers by Size and Material

Angle	Material	Capacity	P/N
90°	acrylic	100 N	346-57806-01 *1
	acrylic	100 N	346-57806-02 *1
45°	acrylic	100 N	346-57806-03 *1
	SS	100 N	346-57806-04 *1
40°	acrylic	100 N	346-57806-05 *1
	SS	100 N	346-57806-06 *1
30°	acrylic	100 N	346-57806-07 *1
	SS	100 N	346-57806-08 *1

## Compression Jigs

### ⑥ Compression plate

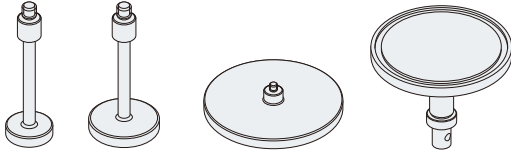

Compression jig set			346-52282-01
Item list	Upper compression plate	ø8	346-51687-03
		ø10	346-51687-04
		ø15	346-51687-06
		ø20	346-51687-08
		ø30	346-51687-10
		ø118	346-51687-11
	Lower compression plate	ø118	346-51687-12

### List of Part Numbers by Size, Material and Capacity

	Diameter (mm)	Material	Capacity	P/N
Upper compression plate	ø8	Steel+Plating	500 N	346-51687-03
	ø10	Steel+Plating	500 N	346-51687-04
	ø11.3 (cross section: 1 cm <sup>2</sup> )	Steel+Plating	500 N	346-51687-05
	ø13	SS	500 N	348-38554
	ø15	Steel+Plating	500 N	346-51687-06
	ø16	Steel+Plating	500 N	346-51687-07
	ø20	Steel+Plating	500 N	346-51687-08
	ø25	Steel+Plating	500 N	346-51687-09
	ø30	Steel+Plating	500 N	346-51687-10
	ø50	AL	500 N	346-57815-01
	ø75	AL	500 N	346-57815-02
	ø100	AL	500 N	348-38556
	ø118	Steel+Plating	500 N	346-51687-11
	ø200 (for 1 kN to 5 kN load cells)	AL	500 N	346-57816-01
Lower compression plate	ø118	Steel+Plating	500 N	346-51687-12
	ø118 (markings at every 20 mm)	Steel+Plating	500 N	346-51687-32
	ø200	AL	500 N	346-57816-02
	ø200 (markings at every 30 mm)	AL	500 N	346-57816-12

## Tensile and Peeling Test Jigs

### ⑦ 500 N tensile jig

Capacity : 500 N  
 Applicable specimen thickness : 5 mm  
 Grip face width : 25 mm

500 N tensile jig set (one each for upper and lower grips)	346-57262-03
500 N upper grip	346-57262-01
500 N lower grip	346-57262-02

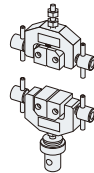

### ⑧ Noodle tensile jig

Capacity : 500 N  
 Applicable specimen size : W 12.7 mm (1/2 in) × T 1.5 to 2 mm

Peeling test jig set		346-52289-01
Breakdown	Rotary drum jig, 1 pc	343-07949-02
	500 N upper grip	346-57262-01

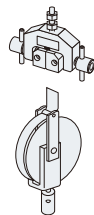

### ⑨ Peeling test jig

Capacity: 500 N

Peeling test (cell) jig	346-52265-01 *2
-------------------------	-----------------

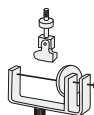

## Application Jigs

### ⑩ Plastic three-point bending jig

Capacity : 5 kN  
 Applicable standards : ISO178, JIS K7171, ASTM D790

Plastic three-point bending jig (for 1 to 500 N load cells)	346-57265-01
Plastic three-point bending jig (for 1 to 5 kN load cells)	346-57265-02

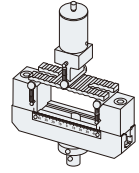

### ⑪ IC Pin test jig

Capacity : 500 N  
 Applicable specimen size : W 40 × L 40 to W 100 × L 100  
 \* Positioning of test piece is made by XY stage.

IC pin test jig set	346-52292-01
---------------------	--------------

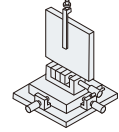

### ⑫ Peeling test jig set

Capacity : 500 N  
 Applicable specimen size : W 40 × L 40 to W 100 × L 100  
 \* Positioning of test piece is made by XY stage.

PCB peeling test jig set	346-52292-02
--------------------------	--------------

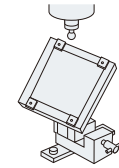

### ⑬ Spring test jigs

Capacity :  
 : Hook 1 for tensile test: 140 N (ø20, D5)  
 : Hook 2 for tensile test: 20 N (ø8, D2)  
 : Compression plate: 500 N (ø118)

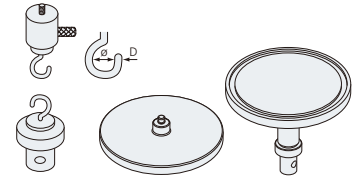

Spring tensile jig	346-52174-02
Upper compression plate dia. 118 mm	346-51687-11
Lower compression plate for spring	346-52189

### ⑭ Friction modulus measurement jig

Capacity : 500 N  
 Applicable standards : (ISO) ISO8295, JIS K7125  
 (ASTM) ASTM D1894, JIS K7312

Friction modulus measurement jig (ISO)	346-53933-74
Friction modulus measurement jig (ASTM)	346-53933-73

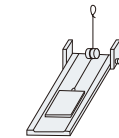

# Jig Part Number List

\*1 : ⊙An upper adapter jig is necessary \*2 : ⊙A lower adapter jig is necessary \*3 : ⊙A jig platform is necessary

## Application Jigs

### 15 Toothed pushrod

Capacity : 500 N  
Punch width : 30 mm

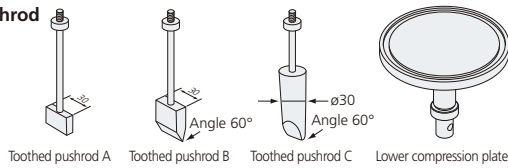

Toothed pushrod set		346-52285-01
Item list	Toothed pushrod B	346-51814-02
	Toothed pushrod C	346-51815-02
	Lower compression plate dia. 118 mm	346-51687-12
Toothed pushrod A (flat end face)		346-52258-02
Toothed pushrod B (60° cut end face)		346-51814-02
Toothed pushrod C (60° round end face)		346-51815-02

### 16 Cutting force test jig

Capacity : 500 N  
Punch width : 30 mm  
Punch angle : 60°  
Base width : 30 mm  
Base V-groove angle : 60°

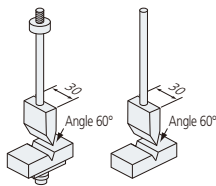

Cutting force test jig	346-51817-01
	346-51817-02 *1 *2

### 17 Wedge-type bite

Capacity : 500 N  
Wedge width : 40 mm

Wedge-type bite jig (30° tip, 40 mm wide)	346-57812 *3
Wedge-type bite jig (45° tip, 40 mm wide)	346-57812-01 *3
Wedge-type bite jig (60° tip, 40 mm wide)	346-57812-02 *3

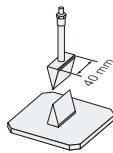

### 18 Wire cutter

Capacity : 5 N  
Effective test width : 80 mm  
Wire diameter : ø0.32 mm (SS Wire)

Wire cutter (upper)	346-57817
---------------------	-----------

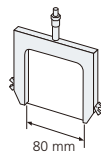

### 19 Cutting stress test jig

Capacity : 5 N  
Wire diameter : ø0.32 mm  
Jig size : Effective test width : 26 mm  
Base size : W15 mm x L60 mm Groove depth : 4 mm

Cutting stress test jig	346-52268-01 *1 *2
-------------------------	--------------------

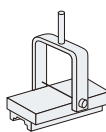

### 20 Razor blade cutting jig

Capacity : 500 N  
Effective test width : 32 mm  
Base width : 30 mm

Razor blade cutting jig	346-51816-01
	346-51816-02 *1 *2

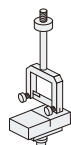

### 21 Volodkevich bite jig

Capacity : 500 N  
Upper and lower teeth width : 10 mm

Volodkevich bite jig set	346-57805 *1 *3
--------------------------	-----------------

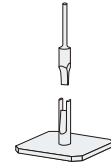

### 22 Blade shear jig

Capacity : 500 N  
Blade size : W70 mm T3 mm  
Blade guide width : 66 mm

Blade shear jig set (60° cut end face, 3 mm thick, with blade)	346-57807 *3
--	--------------

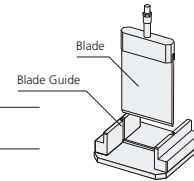

### Individual Blade Part Numbers

A : Flat end face, 3 mm thick	348-38521
B : Round end face (R1.5), 3 mm thick	348-38523
C : 60° cut end face, 3 mm thick	346-58522-03
D : 45° cut end face, 3 mm thick	348-38522-01
E : 30° cut end face, 3 mm thick	348-38522-02
F : 90° V-cut flat end face	348-38524-01
G : 60° V-cut flat end face	348-38524-03
H : 45° V-cut flat end face	348-38524-02

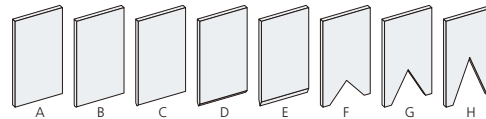

### 23 Three-point bending test jig

Capacity : 500 N

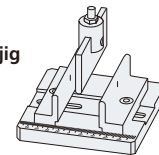

Punch Radius x Width	Support Radius x Width	Distance between support	P/N
R0.1 mm x 80 mm	R0.1 mm x 80 mm	1 mm to 99 mm	346-57820-01 *3
R0.1 mm x 15 mm	R0.1 mm x 80 mm	1 mm to 99 mm	346-57820-02 *3
R1 mm x 80 mm	R1 mm x 80 mm	2 mm to 99 mm	346-57820-03 *3
R2.5 mm x 80 mm	R2.5 mm x 80 mm	5 mm to 95 mm	346-57820-04 *3

### 24 Lower bending test jig

Capacity : 500 N  
Distance between supports : 40 to 60 mm  
Support width : R0.2 mm  
Support radius : 26 mm

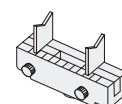
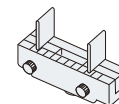

Lower bending test jig (IIS S6005) Flat support type	346-51818-01
Lower bending test jig (V-cut support type)	346-51818-02 *2

Bending test jig set		346-52290-01
Item list	Toothed pushrod B, 1 pc	346-51814-08
	Lower bending test jig	346-51818-01

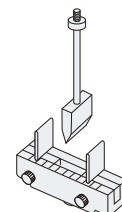



### 25 Lipstick test jig set

Capacity: 500 N

Lipstick test jig set		346-52294-01 *2
Item list	Horizontal lipstick holder	346-52022-01
	Toothed pushrod B, 1 pc	346-51814-02

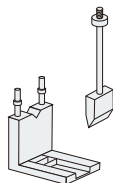

### 26 Spreading jig

Capacity : 50 N  
Conical press jigs : 90° angle  
Sample cup : 90°

Spreading jig (with 5 sample containers)	346-57810 *1 *3
Additional sample container, 5 pcs	346-57810-01

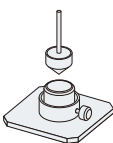

### 27 Snack breaking test jig set

Capacity : 500 N  
Cylinder base : ø40 mm t5 mm  
Spherical press jig : ø8

Snack break test jig set (with 8 mm dia. spherical press jig)	346-57809 *3
---	--------------

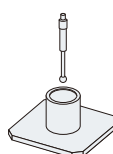

### 28 Base for food elasticity test

Capacity : 500 N  
Spherical press jig : ø8 mm  
Base hole diameter : ø12 mm

Base for food elasticity test	346-52275-02 *2
-------------------------------	-----------------

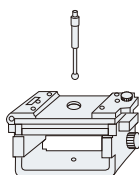

### 29 Tortilla break test set

Capacity : 500 N  
Spherical press jig : ø20 mm

Tortilla break test set, 80 mm dia. hole	346-57814 *3
Tortilla break test set, 60 mm dia. hole	346-57814-01 *3
Tortilla break test set, 40 mm dia. hole	346-57814-02 *3

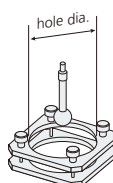

### 30 Gum break shearing test table

Capacity: 500 N

Gum break shearing test table	346-52274-01 *2
-------------------------------	-----------------

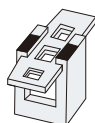

### 31 Kamaboko test set

Capacity: 500 N

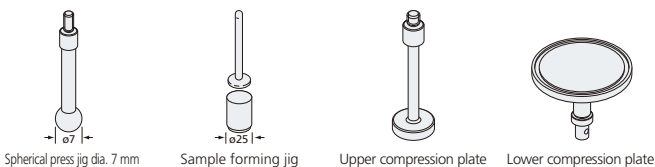

Kamaboko test set		346-52286-01 *1
Item list	Spherical press jig dia. 7 mm, 1 pc	346-52252-03
	Sample forming jig 1 pc	346-52267-02
	Upper compression plate dia. 20 mm, 1 pc	346-51687-08
	Lower compression plate dia. 118 mm, 1 pc	346-51687-12

### 32 Universal-design food test set

Capacity : 500 N  
Applicable : For testing foods intended for people with difficulty swallowing, standard based on the notification issued by the Japanese Consumer Affairs Agency Test about "universal design foods" advocated by the Japan Care Food Conference  
Plunger : ø20 mm H8 mm  
Sample cup : ø40 mm H15 mm

Nursing care foods testing set (with 10 sample cups (H15))	346-57825
Additional sample cups (H15)	346-57825-11
Additional sample cups (H20)	346-57825-12

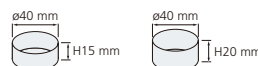
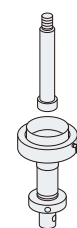

### 33 Gelatinous sample strength evaluation set

Capacity : 100 N  
Applicable standard: JIS K6503  
Glass Bottle : Internal diameter ø60 mm  
Plunger : ø12.7 (ø1/2")

Gelatinous sample strength evaluation set (with 10 glass bottles)	346-57824 *1 *3
---	-----------------

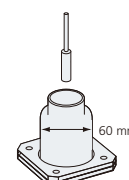

### 34 Kramer shear cell

Capacity : 500 N  
Cell internal size: W63 mm x D68 mm x H84 mm

Kramer shear cell, 5-blade type	346-57808-01 *3
Kramer shear cell, 10-blade type	346-57808-02 *3

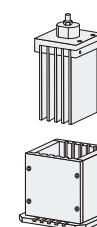

### 35 Mini Kramer shear cell / Ottawa cell set

Capacity : 500 N  
Cell internal size: □33 mm x H44 mm

Mini Kramer shear cell / Ottawa cell set	346-57811 *3
--	--------------

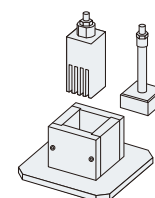

# Jig Part Number List

\*1 : ☉An upper adapter jig is necessary \*2 : ☉A lower adapter jig is necessary \*3 : ☉A jig platform is necessary

## Application Jigs

### 36 Ottawa cell set

Capacity : 500 N  
Cell Internal size: □ 57 mm

Ottawa cell set (accessories)		
Accessories	Plate with 3 mm dia. hole	346-57821 *3
	Plate with 6 mm dia. hole	
	Plate with 3 mm dia. wire	
	Plate with 6 mm dia. wire	

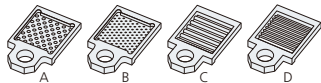

Option

Volume reduction adapter (dia. 46 mm)	346-57821-11
Volume reduction adapter (37 × 37 mm)	346-57821-12

The adapter is inserted into the Ottawa cell to reduce the inner volume. The adapter comes in a set with compression plates.

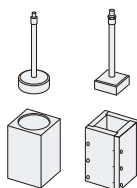
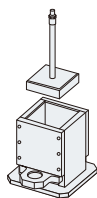

### 41 Boil-in-bag piercing stand

Capacity : 20 N  
Piercing rod : R0.5 mm  
Piercing stand hole : 12 mm dia.

Boil-in-bag piercing stand and rod	346-52271-01 *1 *2
Boil-in-bag piercing rod	347-52778 *1

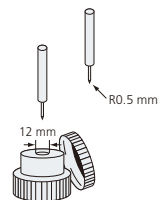

### 42 Syringe extrusion test jig

Capacity : 500 N  
Applicable syringe size: Maximum syringe diameter 30mm

Syringe extrusion test jig		346-57828
Item list	Adapter with 30 mm dia. hole	348-38626-06
	Adapter with 25 mm dia. hole	348-38626-05
	Adapter with 20 mm dia. hole	348-38626-04
	Adapter with 15 mm dia. hole	348-38626-03
	Adapter with 10 mm dia. hole	348-38626-02
	Adapter without hole (The customer can drill a hole as desired.)	348-38626-01

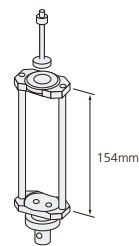

### 37 Tubing test jig

Capacity : 500 N  
Sample container: 50 mm  
Disks with hole (3, 5, 7 or 10 mm dia.) is included.

Tubing test jig		
Accessories	A: Adapter with 3 mm dia. hole	346-57818 *3
	B: Adapter with 5 mm dia. hole	
	C: Adapter with 7 mm dia. hole	
	D: Adapter with 10 mm dia. hole	

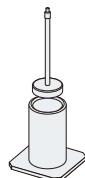

### 43 Syringe needle attachment jig

Capacity : 500 N  
Needle holder size: 4 to 4.5 mm, L10 mm

Syringe needle attachment jig	346-51688-02
-------------------------------	--------------

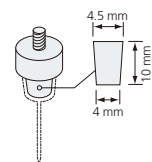

### 38 Overflow test jig set

Capacity : 50 N  
Sample Container: Internal Diameter 50 mm

Overflow test jig set		
Accessories	A: Compression plate adapter dia. 45 mm	346-57813 *1 *3
	B: Compression plate adapter dia. 40 mm	
	C: Compression plate adapter dia. 35 mm	

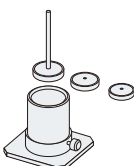

### 39 Roller-type noodle tensile jig

Capacity : 100 N  
Roller diameter: 16 mm

Roller-type noodle tensile jig	346-57826
--------------------------------	-----------

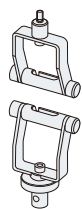

### 44 Toothbrush jig set

This jig set makes it possible to measure the drawing force of bristles of toothbrushes or interdental brushes.  
Capacity : 20 N  
Applicable standard: JIS S3016  
Vice Capacity : 30 mm

Toothbrush jig set (vice)	346-52291-01
---------------------------	--------------

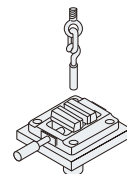

### 45 Tablet press-dispense jig set

Capacity : 500 N  
Punch size: 0.5" dia. (round-tipped)

Tablet press-dispense jig set		346-57819 *1 *3
Accessories	A: Adapter with 17 mm dia. hole	348-38604-02
	B: Adapter with 12 mm dia. hole	348-38604-01
	C: Adapter with 17 mm dia. hole + R5 /L23 mm slotted hole	348-38567
	D: R5 /L23 mm slotted hole (For capsules 1-5)	348-38603

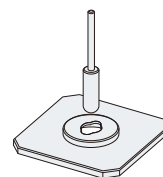
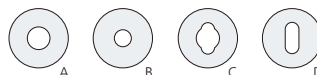

### 40 Noodle tensile jig (Sponge-grip type)

Capacity: 50 N

Noodle tensile jig	346-522640-01
--------------------	---------------



## Application Testing Base

### ④⑥ Beaker fixing base

Capacity: 500 N

Beaker fixing base	346-51819-02 *2
--------------------	-----------------

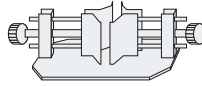

### ④⑦ Fixing base

Capacity: 500 N

Fixable sample size: ø25 to 60 mm

Fixing base	346-51819-01
-------------	--------------

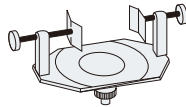

### ④⑧ Waterproof tray

Waterproof tray	346-57115
-----------------	-----------

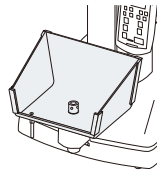

## Jig Mounting Adapters

### ④⑨ Sun Scientific jig mounting adapter set

Jigs from Sun Scientific Co., Ltd. can also be used with EZ Test.

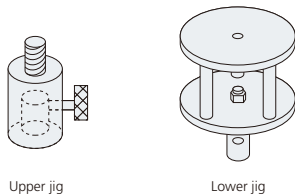

Upper jig

Lower jig

Sun Scientific jig mounting adapter set		346-52295-01
Item list	Upper jig, 1 pc	346-52280-01
	Lower jig, 1 pc	346-52281-02

### ⑤⑩ Rheotech jig mounting adapter set

Jigs from Rheotech can also be used with EZ Test.

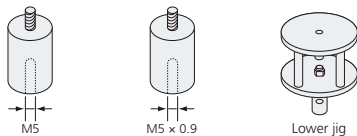

M5

M5 x 0.9

Lower jig

Rheotech jig mounting adapter set		346-51820-03
Item list	M5 screw	346-51820-01
	M5 0.9 mm pitch screw	346-51820-02
Lower jig		346-52281-01

### ⑤⑪ Jig platform

\*3 Can be used for various tests by removing the plate on the platform and switching the jig for a different type.

Jig platform (with standard plate and sample tray)	346-57823
---	-----------

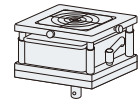

### ⑤⑫ Upper jig

\*1 An upper adapter jig is necessary to allow smooth probe replacement.

Upper jig	346-52280-01
-----------	--------------

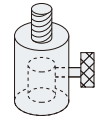

### ⑤⑬ Lower jig

\*2 Attaching a probe to the upper jig and an adapter to the lower jig allows smooth switching between different types of test jigs.

Lower jig	346-52281-02
-----------	--------------

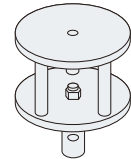

### ⑤⑭ Adapter for AGS series jig

Use these adapters when mounting the Shimadzu AGS Series Precision Universal Tester jig to the EZ Test tester.

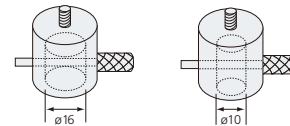

AGS series jig adapter dia. 16 mm	346-51692-01
AGS series jig adapter dia. 10 mm	346-51692-02

### ⑤⑮ 1 to 5 kN load cell adapter

Use this adapter when mounting a jig to a 1 kN, 2 kN or 5 kN load cell.

M12 conversion adapter	347-55350-01
------------------------	--------------

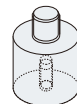

### ⑤⑯ Probe extension adapter

Use these adapters to extend probes. Take care not to apply a bending force onto the load cell.

Probe 30-mm extension adapter	348-38500-03
Probe 60-mm extension adapter	348-38500-04
Probe 30-mm extension adapter (with lock nut)	346-59376-01
Probe 30-mm extension adapter (with lock nut)	346-59376-02

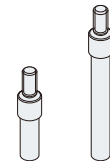

## Testing and Evaluation Machines

Table-Top Type Universal Testing Instruments  
AGS-X Series



Electromagnetic Force Fatigue /  
Endurance Testing System  
EMT Series



Electromagnetic Force Micro Material Tester  
Micro-Servo MM Series

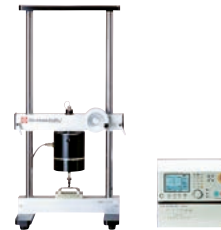

High-Speed Impact Testing Machines  
HITS-X Series



Dynamic Ultra Micro Hardness Tester  
DUH Series

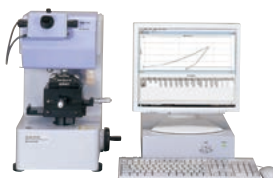

Constant Test Force Extrusion Type  
Capillary Rheometer  
Flowtester CFT-EX Series



YouTube

Application videos are available on YouTube!

Search for the "Compact Table-Top Universal Tester" playlist on the Shimadzu YouTube Channel.



 SHIMADZU

Shimadzu Corporation  
[www.shimadzu.com/an/](http://www.shimadzu.com/an/)

**For Research Use Only. Not for use in diagnostic procedures.**

This publication may contain references to products that are not available in your country. Please contact us to check the availability of these products in your country.

Company names, products/service names and logos used in this publication are trademarks and trade names of Shimadzu Corporation, its subsidiaries or its affiliates, whether or not they are used with trademark symbol "TM" or "®".

Third-party trademarks and trade names may be used in this publication to refer to either the entities or their products/services, whether or not they are used with trademark symbol "TM" or "®".

Shimadzu disclaims any proprietary interest in trademarks and trade names other than its own.

The contents of this publication are provided to you "as is" without warranty of any kind, and are subject to change without notice. Shimadzu does not assume any responsibility or liability for any damage, whether direct or indirect, relating to the use of this publication.