

Laser Diffraction Particle Size Analyzer

SALD-2300



Applicable to a Wide Range of Applications Using
Optional Units and Application Software Packages
Provides Accurate Evaluation of the Change in Particle
Size Distribution, Conforming to ISO13320

Laser Diffraction Particle Size Analyzer

SALD-2300



Laser Diffraction Particle Size Analysis?

Particle size distribution can be calculated using the light intensity distribution pattern of scattered light which is generated from sample particles when laser irradiates them.

This is the main particle size analysis method because it has excellent properties such as a wide measurement range, a short measurement time, and the ability to measure both wet and dry samples.

Please refer to page 19 for the measurement principle.

Wide applicability

High resolution

High concentration

High repeatability

High reliability

High sensitivity

High throughput

High efficiency

High analysis capability

Powerful new functions have been added to accurately evaluate the change in particle size distribution.

Particle size distribution can have a major effect on the characteristics desired for a given application or objective, or on the performance and quality of a final product.

A particle size analyzer with the ability to precisely measure particle size distribution is an essential tool in today's laboratory. The SALD-2300 is that tool. With a variety of optional units and application software packages, the SALD-2300 can easily address the application requirements in a variety of industries, including pharmaceuticals, cosmetics, foods, drinks, pigments, paints, ceramics and electronic materials.

The following three functions have been added to ensure the accurate evaluation of changes in particle size distribution, which is caused by time course or particle concentration.

- 1 Wide particle concentration range from 0.1ppm to 20%.
- 2 Continuous measurement function at minimum 1-second intervals
- 3 Wide measurement range from 17nm to 2500 μ m

SALD-2300 maintains data compatibility with previous products such as the SALD-2001, SALD-2101, and SALD-2201.

Wide applicability

- Using the SALD-MS23 sampler, the measurement range is 17nm to 2500 μ m for wet measurement.

For example, PSL particles with a median diameter of 50nm and stainless balls with a diameter of 2mm can be measured by a single analyzer.

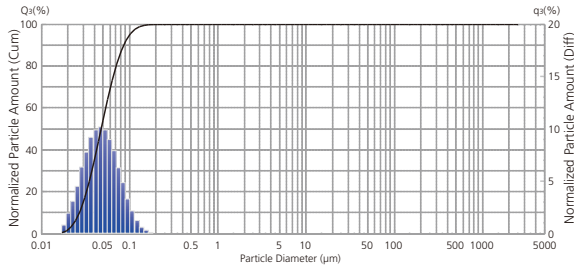

PSL particles 50nm median diameter

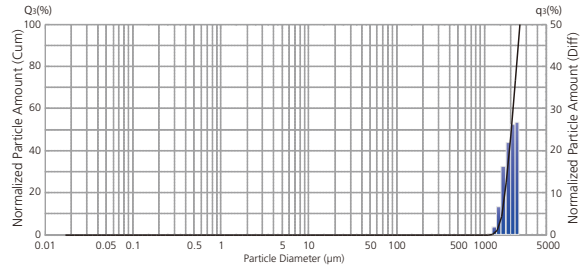

Stainless balls of 2mm diameter

- The system configuration can be optimized to address various uses, purposes, measurement objects, environments and conditions.

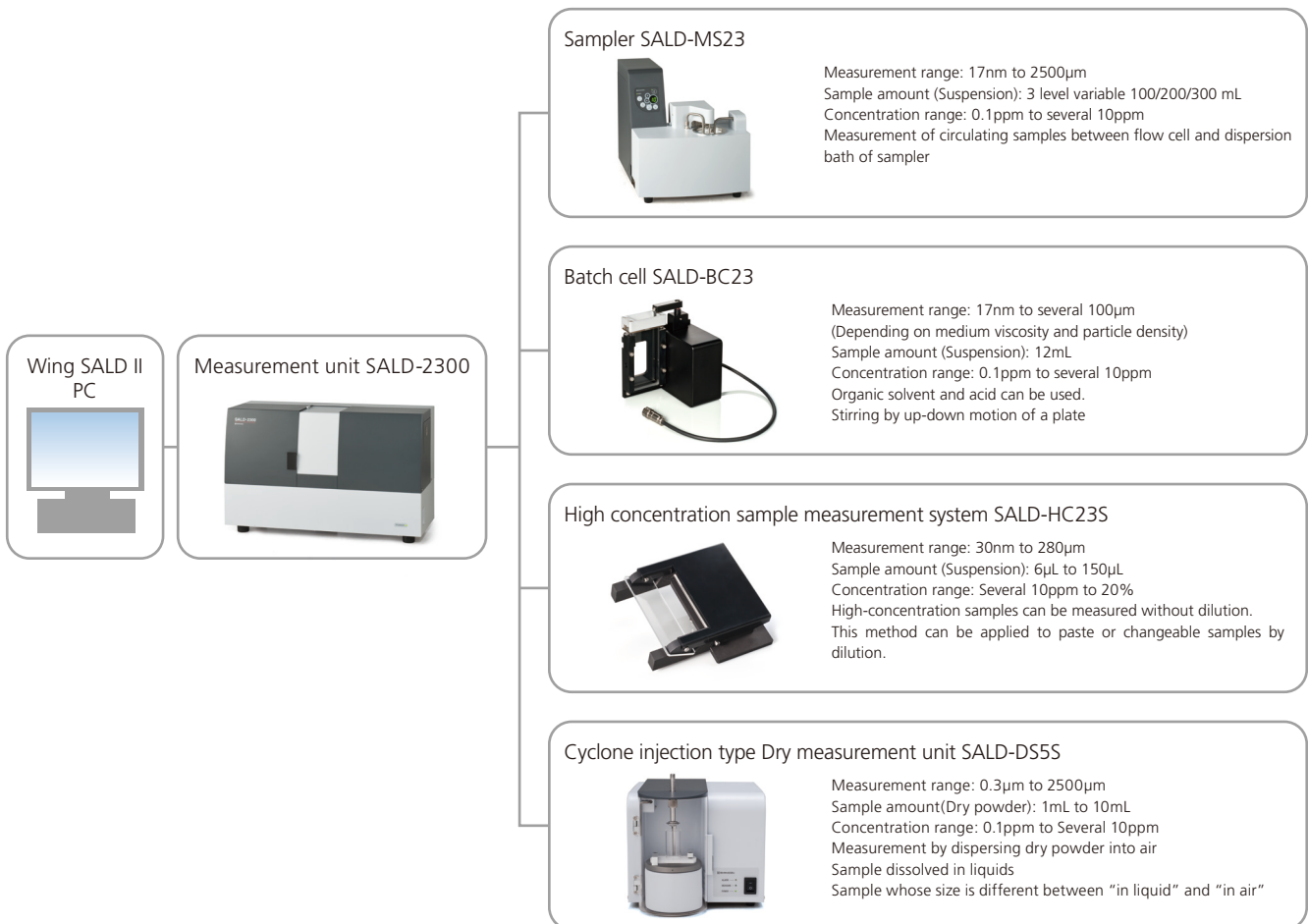

- Various sample amounts (Suspension) can be selected according to measurement objects and purposes.

- Sample amount for SALD-MS23 is variable: 100mL, 200mL, or 300mL.
- Sample amount for batch cell SALD-BC23 is 12mL.
- In the case of high-concentration sample measurement system SALD-HC23S, optional indentation can be used for sample amounts ranging from 6 μ L to 150 μ L.

High resolution

Accurately detects particle size distribution with five peaks

Scattered light from coarse particles is concentrated at low angles near the optical axis and fluctuates vigorously within a tiny angle, but scattered light from microparticles fluctuates slowly up to large angles away from the center. Whereas the intensity of scattered light from coarse particles is extremely high, the intensity of scattered light from microparticles is very low. The SALD-2300 achieves high resolution over a wide range of particle sizes by utilizing the relationship between particle size and scattered light and increasing the detection surface area of each of the 78 concentric detector elements in the Wing Sensor II at a logarithmic rate from the center outward. In addition to the Wing Sensor II, one sensor is used for side scattered light and five sensors are used for backward scattered light.

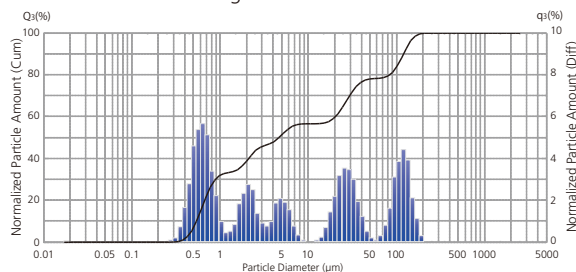

Particle Size Distribution Data with Five Peaks

Reliably reproduces particle size distributions with complicated distribution shapes. This is an example of measuring a mixture of five types of particles, with diameters of 0.7, 2, 5, 25, and 100 μm.

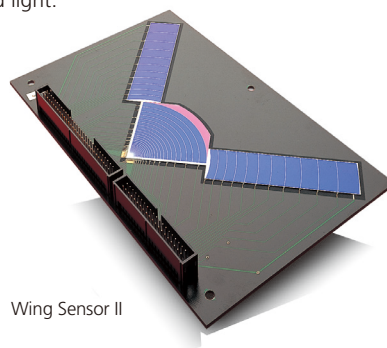

Wing Sensor II

High reliability

- Laser diffraction method ISO 13320 and JIS Z 8825-1 compliant

Complies with ISO 13320 and JIS Z 8825-1 laser diffraction and scattering standards.

- Instrument validation with JIS standard particles

System performance can be confirmed using MBP1-10 standard particles specified in JIS Z 8900-1. These samples have a broad particle size distribution; using these samples enables verification of the instrument's accuracy.

- Easy maintenance

A powerful self-diagnostic function allows checking the output signals from each sensor and detection element and the system's functional status. The operation log function stores detailed information with all measurement data, such as the operating status and cell contamination status. This allows retroactively verifying the validity of measurement data and confirming the cell contamination status.

- Allows verifying measurement results (particle size distribution data) by light intensity distribution data (raw data)

Since light intensity distribution data (raw data) and measurement results (particle size distribution data) can be displayed on the same screen, measurement results can be verified while viewing both sets of data. In addition to verifying whether the detection signal level (particle concentration) is appropriate or not, this enables confirming the validity of measurement results from multiple aspects, such as in terms of the distribution width and the presence of aggregates and contaminants.

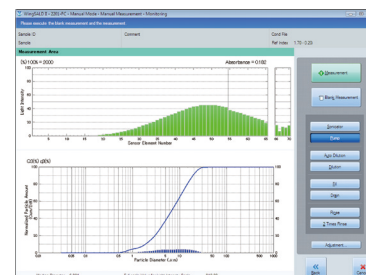
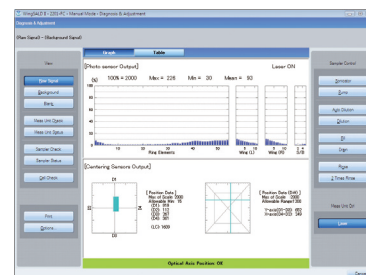

High reproducibility

Improved stability of the optical system

SALD systems utilize an OSAF (Omnidirectional Shock Absorption Frame), which completely isolates all elements of the optical system from impacts, vibration, and other external disturbances. Therefore, optical axes rarely need adjustment.

High efficiency / High reliability

Automatic refractive index calculation function eliminates the mistake or trouble of selecting refractive indices.

Automatic Refractive Index Calculation Function Is Available.

Selecting a refractive index was an unavoidable part of using the laser diffraction method, in which a published value was generally entered. However, such values were not necessarily appropriate, considering the effects of particle composition and shape. Therefore, tedious trial and error processes were used to select refractive indices.

WingSALD II solves such problems by being the world's first software to include a function that automatically calculates an appropriate refractive index based on the LDR (light intensity distribution reproduction) method.

Note: The LDR method automatically calculates an appropriate refractive index based on consistency between the actual measured light intensity distribution and one reproduced (recalculated) from particle size distribution data. This method was developed by Shimadzu and published in two technical papers. It is sometimes called the "Kinoshita Method", in academic communities, after the name of Shimadzu's engineer.

The refractive index of main materials can be selected in the list.

The image displays a sequence of three steps in the WingSALD II software interface:

- (1) Specify a range for the refractive index:** The 'Selection of Refractive Index' dialog box is shown. The 'Range Specified by Material Name' option is selected. The 'Material of Sample' is set to '103 Polystyrene'. The 'Refractive Index' section shows a 'Starting Point' of 1.40 and an 'End Point' of 1.80. A small graph shows the refractive index range from 1.35 to 4.00.
- (2) Evaluate:** A yellow arrow points from the dialog box to the 'Result' window.
- (3) Display candidates from refractive index and particle size calculation results:** The 'Result' window displays four candidate refractive indices. The first candidate is highlighted with a blue oval. The 'Result' window also shows a 'Single Graph' and an 'Overlay Graph' with 'Particle Diameter (μm)' on the x-axis and 'Light Intensity' on the y-axis. The 'Absorbance = 0.128' is displayed.

Candidate	Refractive Index Range	Median Diameter (μm)	Modal Diameter (μm)
1	1.50-0.01 (0.958)	3.066	4.008
2	1.75-0.00 (0.997)	3.188	4.008
3	1.90-0.00 (0.997)	3.135	4.008
4	1.50-0.00 (0.997)	3.135	4.008

High efficiency / High reliability

Assist function decreases operational error to ensure more accurate measurement.

Measurement Assistant Function Allows Preparing SOPs to Ensure Measurements Are Always Performed Using the Same Conditions and Procedures.

Anyone can conduct high-quality measurements anywhere at any time.

With the SALD-MS23, SALD-BC23, and SALD-DS5S, automatic measurement by PC control can be conducted according to a specified SOP. The operator's work consists of sample preprocessing and inputting only.

Creating, saving, and sharing measurement conditions and procedures, including pretreatment methods and conditions, ensures measurements are performed using the same conditions and procedures, even if performed by a different operator or at a different location or plant, and ensures safe comparison of data.

Furthermore, when the measurement assistant function is used, measurement instructions for the operator are displayed on the screen. This enables even inexperienced operators to perform measurements correctly.

Various functions and operations of SALD-2300 can be controlled by a PC, enabling SOPs to be used more effectively.

In addition, administrators and operators can be assigned different operating privileges to ensure security.

Note: SOP is an acronym for Standard Operating Procedure.

The image displays three screenshots of the SALD-2300 software interface, illustrating the Measurement Assistant Function and security features.

Measurement Setup: The main window shows a sidebar with a tree view of measurement steps. The "Preprocessing of sample" step is highlighted with an orange box. A yellow arrow points to the "Work Instructions" dialog box, which contains a "Work Name" field, a "Save a Task" button, and a list of instructions: "Preprocessing procedure (1)Measure sample A by the balance to become 100mg. (2)Add dispersing agent B, and let me become familiar enough. (3)Add water 100ml, and stir it." Below the instructions are "Auto Start" and "Manual Start" radio buttons.

Preprocessing of sample: A separate dialog box displays the same instructions as the "Work Instructions" dialog, with "OK" and "Stop" buttons at the bottom.

Administrator Settings: The "Set Regular User Rights" section is highlighted with an orange box. It includes checkboxes for "Manual Mode", "Set Data Emulation Table", "Scattering Angle Evaluation", "Mixture Data Simulation", and "Data Connection". Below this section are fields for "Set Administrator Password...", "Default", "OK", and "Cancel".

Three blue callout bubbles provide context:

- "Create and save measurement conditions and procedures (SOP)" points to the "Preprocessing of sample" step in the sidebar.
- "Procedures, remarks, and other information are displayed interactively during measurements. This standardizes measurement procedures and prevents mistakes." points to the "Work Instructions" dialog box.
- "Includes security features that limit the functionality available to operators" points to the "Set Regular User Rights" section in the Administrator Settings dialog.

High sensitivity / High concentration

By enabling measurement under wide particle concentration conditions (0.1ppm to 20%), changes in particle size distribution depending on particle concentration can be evaluated.

Previously, the particle concentration of a sample had to be adjusted to meet the optimum conditions of analyzers by dilution or concentration using a centrifuge. In these cases, changes in particle size distribution, such as agglomerations or dispersions, could not be considered.

Dispersions and agglomeration can be caused by dilutions.

In some cases, dilutions can accelerate dispersions, but in other cases, they can create agglomerates.

To ensure optimum, the initial particle concentration must be determined without dilutions or concentrations.

After the evaluation of particle size distribution at the initial state, the effects of particle concentration from dispersions and agglomerations must be evaluated.

Wide particle concentration range must be covered to evaluate the dissolution process of sample particles.

This is necessary because the progress of dissolution makes the particle concentration low in comparison to the first particle concentration.

SALD-2300 can measure particle size distribution under the conditions of particle concentration from 0.1ppm to 20%.

When the sampler SALD-MS23 or batch cell SALD-BC23 is used, measurements are possible under conditions of concentration from 0.1ppm to 100ppm.

When the high-concentration sample measurement system SALD-HC23S is used, high-concentration samples up to 20% can be measured because the negative effects of multiple scattering are prevented.

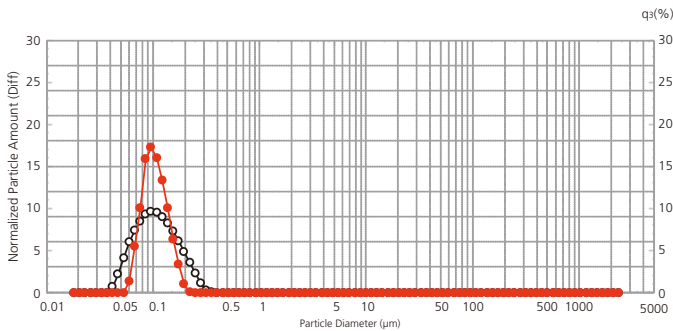

Measurement without dilution of hand cream
In the case of hand cream, dilutions make the particle size distribution narrow.

Measurements without dilutions must be done to obtain accurate measurement.

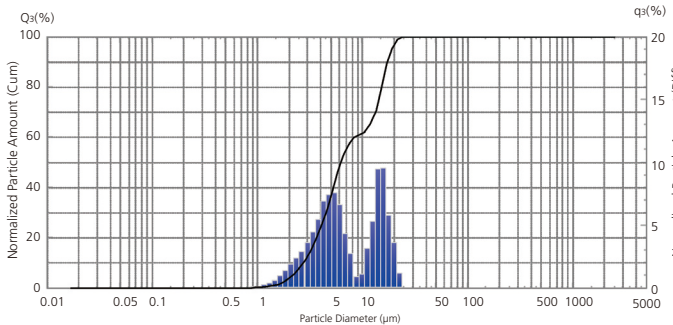

Evaluation of a fine particle included in red wine

The graph to the left shows the result of measuring red wine in the state of the undiluted solution.

The low-concentration sample can be measured as an undiluted solution.

Measuring it in this state can remove the influence of dispersion or agglomeration by the concentration operation.

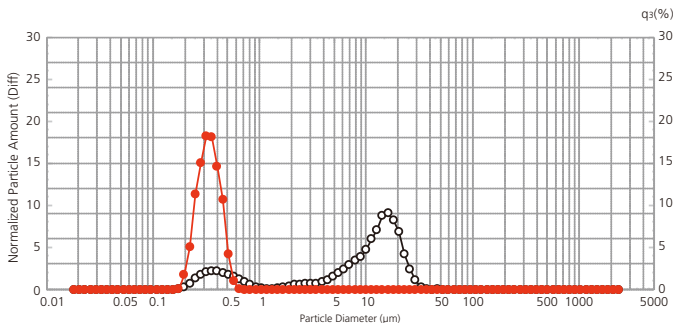

Evaluation of negative electrode material of a secondary battery

At left is a graph showing the results of measuring a carbon black particle.

The agglomeration particle (micrometer range) has been dispersed to the fine particle (sub-micrometer range) by dispersion processing using a homogenizer. The sample (sample that absorbs light like the carbon black) that doesn't transmit light easily can be measured based on the improvement in sensitivity.

High speed

Changes in particle size distribution can be monitored in real-time. Continuous measurement function at 1-second intervals can record these processes for additional analysis.

Particle size distribution data and light intensity distribution data can be displayed in real-time.

This means that sample changes over time or shifts in the dispersion status can be monitored in real-time.

Since both the light intensity distribution data, which is the raw data, and particle size data can be monitored simultaneously, they can be compared to keep track of any changes in the status of samples.

Continuous measurement can record a maximum of 200 data sets at minimum 1-second intervals.

Maximum 200 particle size distributions at minimum 1-second intervals can be measured and stored continuously. These data can be analyzed from various angles using statistical processing, time series analysis and 3-dimensional graph functions.

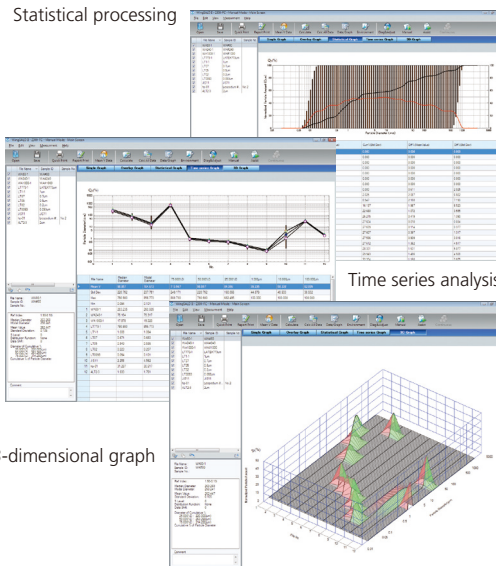
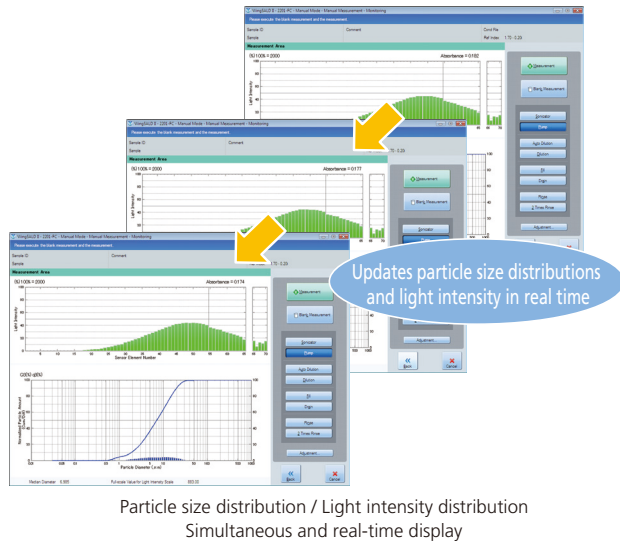

Cross reference of particle size distribution and light intensity distribution enables multilateral evaluations of dissolution process.

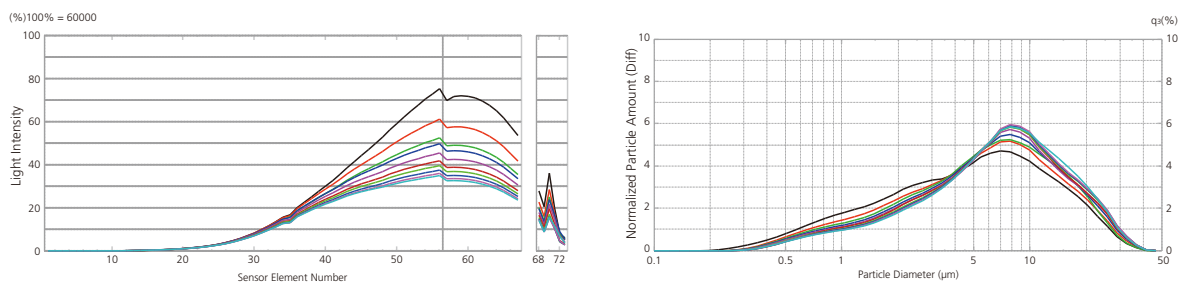

This is an example of light intensity distribution data and particle size distribution data for the dissolution process of calcium carbonate. It shows how dissolution progresses from smaller diameter particles and how the normalized amount of large particles increases.

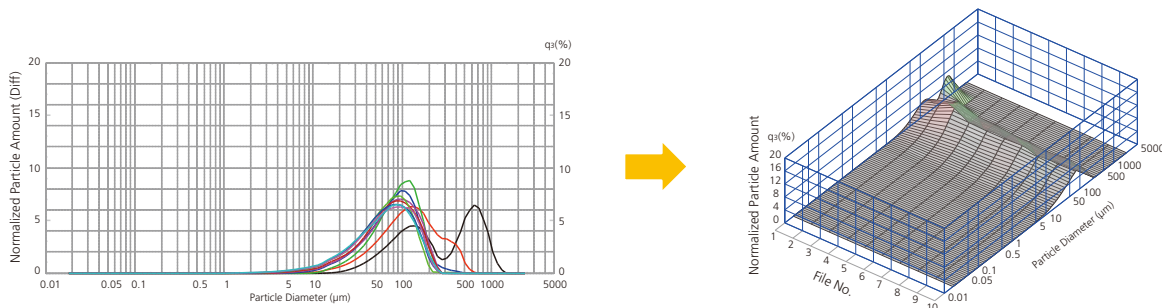

This is a result of measuring the process by which a powdery digestive medicine is distributed into water.

The particle size distribution can be displayed by the 3D graph. In a 3D graph, the dispersion process that changes from the large particle to the small particle is easily viewed.

System Structure

Wide range of system configurations can be designed by adding optional units.



Measurement Unit SALD-2300

The batch cell and the high-concentration sample measurement system can be set in the measurement unit.

- Small-Volume Measurement System (SALD-2300 and SALD-BC23)
- High-Concentration Sample Measurement System (SALD-2300 and SALD-HC23S)
- Very Small-Volume Measurement System (SALD-2300 and SALD-HC23S and "Glass Slides with Indentation")

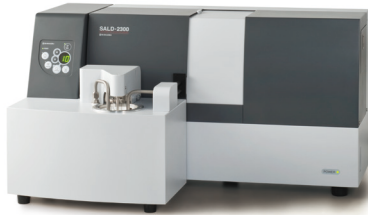
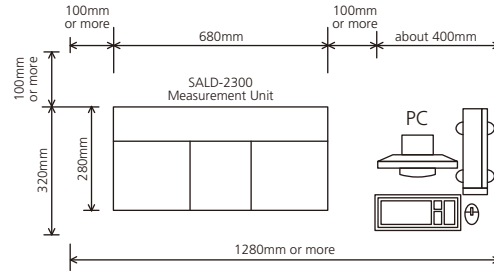

Wet Measurement System (SALD-2300 and SALD-MS23)

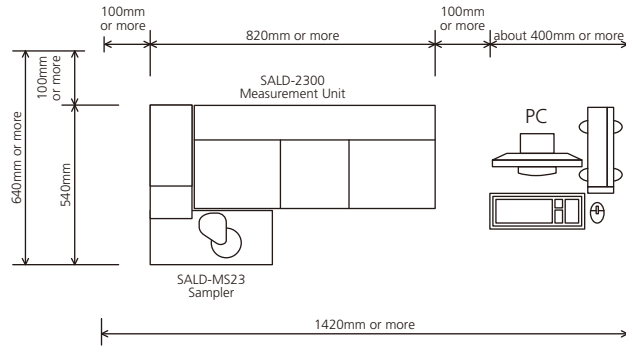

Dry Measurement System (SALD-2300 and SALD-DS55)

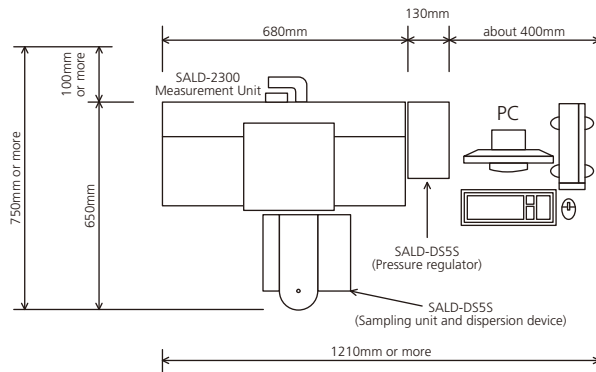

Wet/Dry Measurement Full System (SALD-2300 and SALD-MS23 and SALD-DS55)

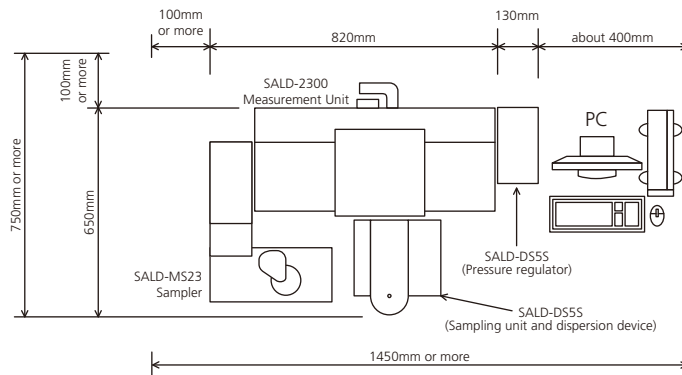

System Configuration

Wet measurement for small amount of sample / Almost all dispersion media can be used.

Batch Cell SALD-BC23



- Measures using small quantities of samples (particles being measured) and liquid media (dispersion media).
- Organic solvents or acids can be used.
- Less liquid waste is disposed of when using suspensions containing organic solvents or acids.
- Vertical motion of the stirring plate inhibits settling of particles. A funnel made of tetrafluoroethylene resin is included to prevent spilling the suspension. This reduces the chance of getting it on hands or fingers and prevents contaminating the cell surface.

Measurement Results

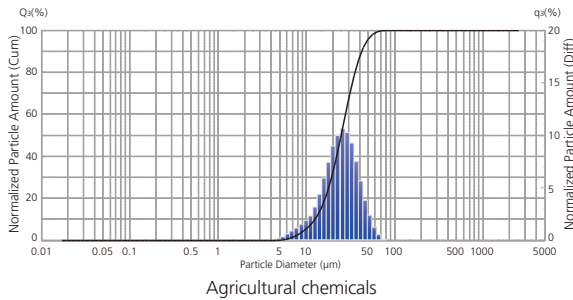

Agricultural chemicals

Particle size distribution may affect the aerial spraying property and resistant toxicity. Disposal of the sample after measurement is easy because the sample amount is small.

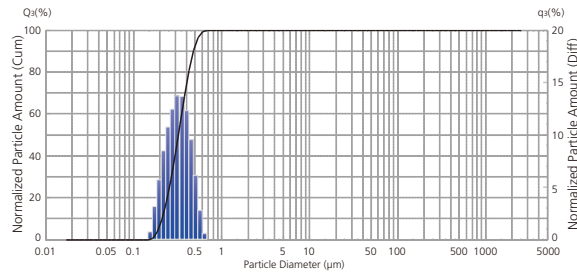

Silicon

Particle size distribution is one of the very important quality control items because it may influence the yield of final products

General wet measurement for a variety of samples

Sampler SALD-MS23

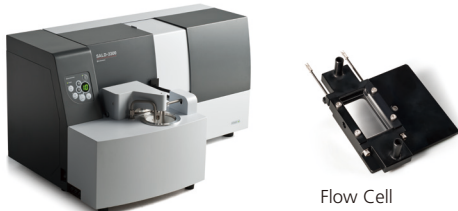

Flow Cell

- Groups of particles are dispersed in a liquid medium and measured as they are circulated between the flow cell, which is placed in the measurement unit, and a dispersion bath in the sampler.
- The dispersion bath incorporates a stirrer and an ultrasonic sonicator. A pump delivers the dispersed suspension to the flow cell.
- The pump is specially designed to ensure both the liquid medium and the particles are circulated. A stainless ball of 2mm circulates and it is possible to measure it.
- Most organic solvents can be used as dispersion media.
The sample quantity is changeable. 100mL, 200mL or 300mL can be selected.

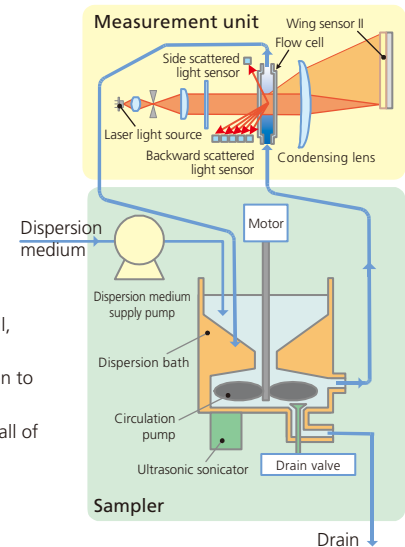

Measurement Results

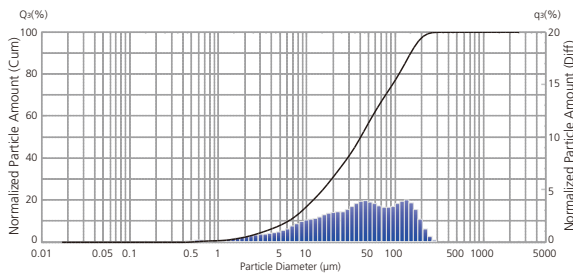

Soybean powder

SALD-2300 can accurately measure samples which have wide distributions and complex profiles.

Soybean powder is a material which is used to make various foods. Its particle size distributions can affect quality, taste, tongue feeling and teeth feeling.

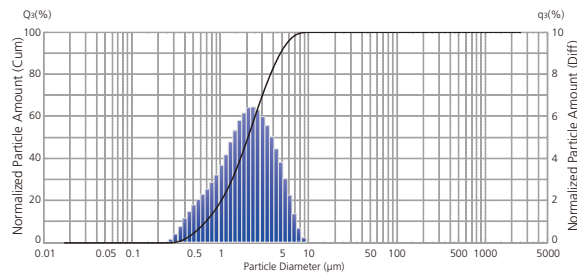

Zirconia

Zirconia can be used as a heat-resistant ceramics material.

For ceramics products, particle size distribution is one of the most important quality control items, because the strength and heat-resistant property can depend on particle size distribution.

Measurement without Dilution

High-Concentration Sample Measurement System SALD-HC23S

- High-concentration samples can be measured using the laser diffraction method.
- Measurement is possible by simply holding the high-concentration sample particles between two glass slides.
- Samples for which the particle size distribution would be changed by dilution can be measured in their original state, or with the minimum required level of dilution, and true images of the measurement object can be obtained.
- Commercial hand creams, face creams, and rinses can be measured with hardly any pretreatment.

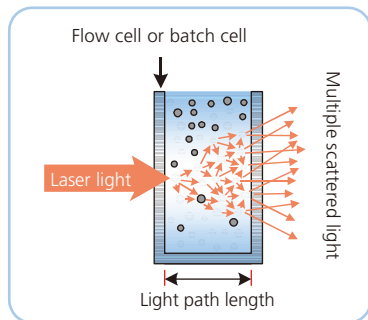

Measurement with Standard Flow Cell or Batch Cell

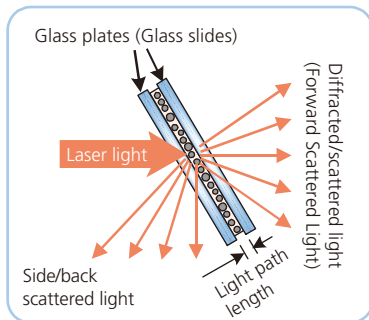

Sample Held between Two Glass Slides

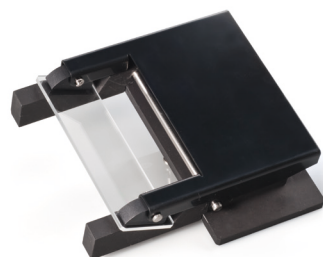

Cell Holder for High-Concentration Sample Measurement System

If a standard flow cell or batch cell is used to measure a sample at a high concentration, the long light path length results in multiple scattering, making it impossible to obtain accurate measurements.

With this system however, is possible by simply holding the high-concentration sample particles between two glass slides, which shortens the length of the light path, avoids the negative effects of multiple scattering and makes accurate measurement possible.

- Glass sample plates (glass slides with indentation) (Standard accessory)

Effective for measurement of samples with relatively low concentrations, or expensive samples that can only be used in small amounts.

Name	Indentation depth	Number	Sample volume	Particle concentration (% by weight)
Glass sample plate (0.02mm)	0.02 mm (20 μm)	2	0.006cm ³	A few hundred ppm to a few percent
Glass sample plate (0.05mm)	0.05 mm (50 μm)	1	0.015cm ³	
Glass sample plate (0.1 mm)	0.1 mm (100 μm)	1	0.03cm ³	
Glass sample plate (0.2 mm)	0.2 mm (200 μm)	1	0.06cm ³	
Glass sample plate (0.3 mm)	0.3 mm (300 μm)	1	0.09cm ³	
Glass sample plate (0.4 mm)	0.4 mm (400 μm)	1	0.12cm ³	
Glass sample plate (0.5 mm)	0.5 mm (500 μm)	1	0.15cm ³	

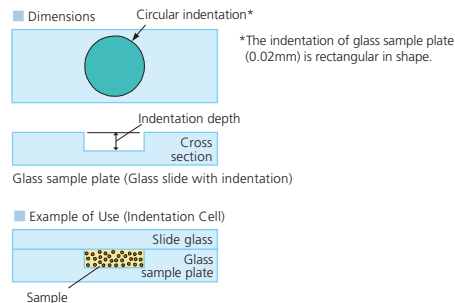

Measurement Results

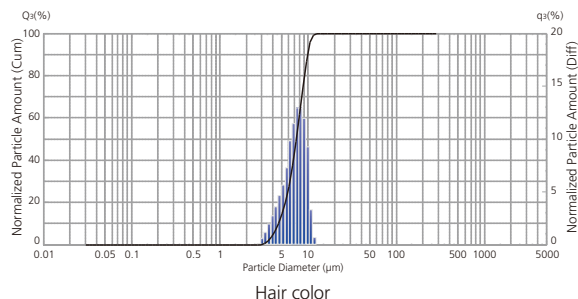

Hair color

Properties of hair color such as color, gloss and adhesive strength depend on particle size distribution. And these properties can determine its product value. Particle size distribution of these kinds of samples may be changed by dilutions, so high-concentration sample measurement without dilution is better.

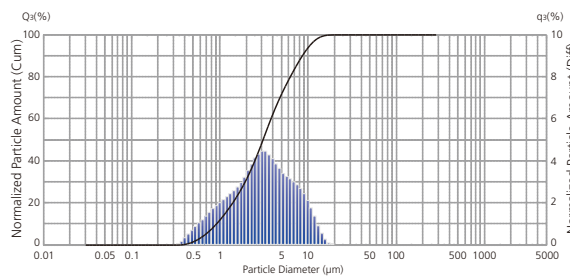

Eye drop medicine

Particle size distribution of eye drop medicine may adversely affect the medicine as well as the feeling of an eye, which is very sensitive. Measurement of the initial particle concentration without dilution is essential.

System Structure

Powder samples can be measured without preparation.

Cyclone Injection Type Dry Measurement Unit SALD-DS55

A cyclone type sample suction mechanism has been developed.

Strong double dispersion process of suction and injection can be used.

Measurement with high precision, high sensitivity, high reproducibility and high resolution

- Sample to be applied
 - Easily dissolved samples (medicine, powder foods)
 - Easily agglomerated samples (magnetized particles)
- Features
 - Using three types of sample suction mechanism (cyclone type, one shot type, hand shot type) and four types of dispersion nozzle, the optimum combination can be selected to perform measurements based on the sample properties and amount.
 - When the cyclone type is used, the sample loaded in the special sample holder is sucked in while being rotated, then injected from the nozzle and measured. In addition, since a sample holder is used, there is no scattering of the sample nor do the operator's hands become soiled.
 - When the one shot type is used, putting the sample into a small hopper is the only operation required for measuring. This type is suitable for a small sample amount. (option)
 - When the hand shot type is used, the sample can be sucked directly from the beaker or chartula for measurement. (option)

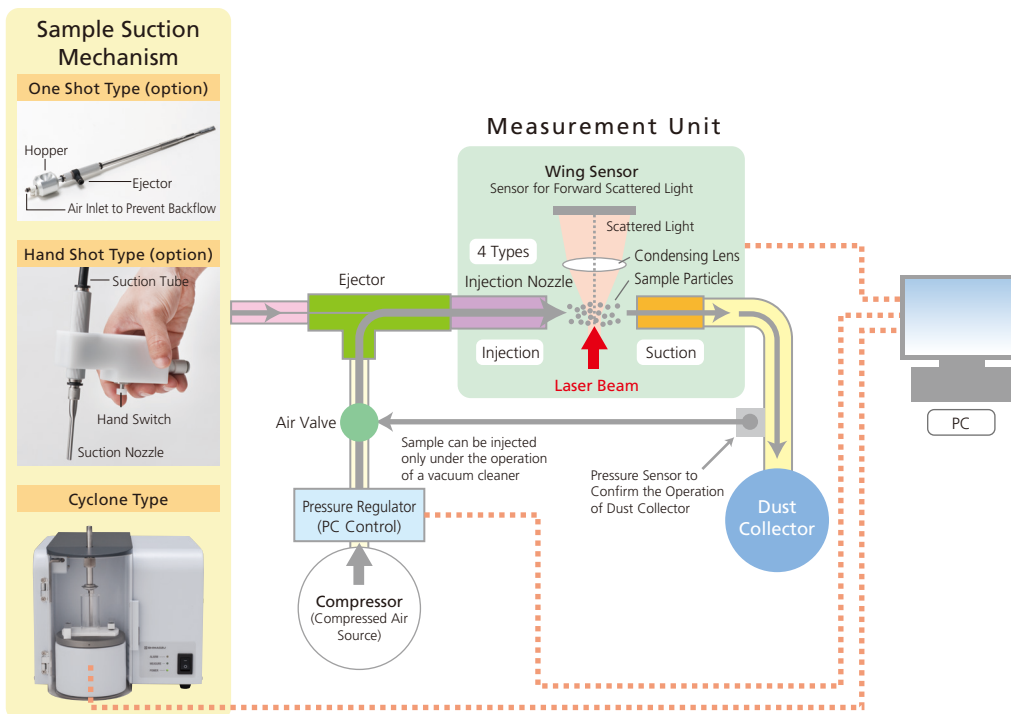

Standard dispersion nozzle (Type 1)

3 mm dispersion nozzle (Type 2 *1)

2.5 mm dispersion nozzle (Type 3 *1)

Straight nozzle (Type 4 *2)

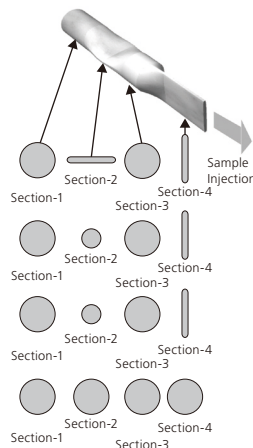

- When compressed air, including the sample, flows through the injection nozzle, the shape, area, and direction of the cross section is changed in order to obtain the large changes in volume, pressure and direction of air flow. Therefore, agglomerates can be strongly dispersed into air.
- In order to obtain the optimum dispersion based on the properties of the sample one of four differently shaped nozzles can be selected.
- Magnetized particles, which are easy to cohere in liquid, can be strongly dispersed into air using the type 1 injection nozzle. Therefore, accurate measurement results can be obtained.
- Using a type 4 dispersion nozzle the dispersion force is weakened, enabling measurements to be made without destroying fragile particles.
- Using type 2 and 3 dispersion nozzles the dispersion force is strengthened, that is suitable for the dispersion of fine particles.
- When the cyclone type is used, the double dispersion process of suction and injection enables measurement with good reproducibility.

*1 Type 2 and Type 3 are set options *2 Type 4 is an option

Measurement Results

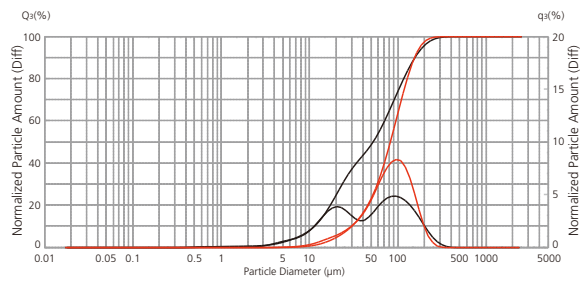

— Hard flour
— Soft flour

Dispersion of flour by water is so difficult that organic solutions such as IPA must be used for wet measurement.

Cyclone injection mechanism can disperse flour in air easily, enabling dry measurement with good reproducibility.

Moreover, the sample can be gathered into a vacuum cleaner and disposed of easily.

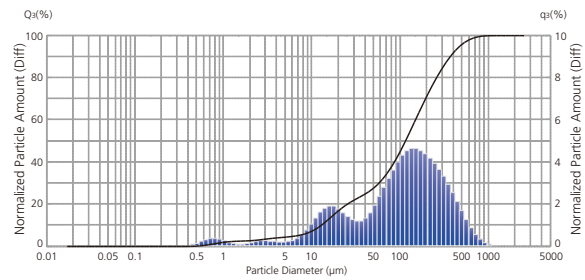
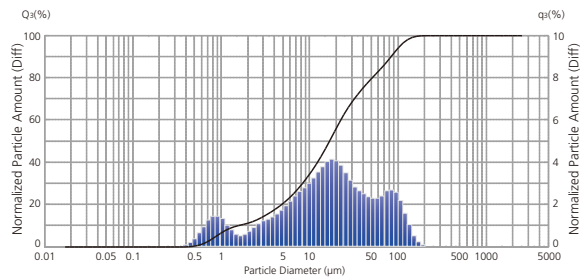

2 types of gastrointestinal medicines

Dissolubility depends on particle size distribution and may adversely impact the measurement of pharmaceuticals. Dry measurement is necessary to measure pharmaceuticals with dissolution effects.



Hardware Specifications

General Specifications

Measurement principle	Laser Diffraction Method
Measurement range	SALD-MS23: 17nm(0.017µm) to 2500µm SALD-BC23: 17nm(0.017µm) to 400µm SALD-HC23: 30nm(0.030µm) to 280µm SALD-DS5: 300nm(0.3µm) to 2500µm

Note 1: The measurement range varies according to the shape etc. of the particle.

Measurement Unit: SALD-2300

Light source	Red Semiconductor laser (Wavelength 680 nm)
Light detector	Detector elements for UV semiconductor laser Total 84 elements (78 forward, 1 side, 5 back)
System Compliance	Class 1 Laser Product, CE compliant
Required power supply	115 or 230 VAC as ordered 100 VA
Dimensions & weight	W680mmxD280mmxH430mm, 31kg
Operating Environment	Temperature: 10 to 30°C, Humidity: 20 to 80 % (no condensation)

Note 2: Reference sample and USB cable (2 m) supplied as standard

Sampler: SALD-MS23

Dispersing bath	Capacity: 100~280cm ³
Sonicator	Frequency about 32 kHz, output about 40 W
Liquid Pump	Radial pump, maximum flow rate 2000cm ³ /min
Liquid Pump Material	Stainless (SUS 304, SUS 316), Tetrafluoroethylene (PTFE), Perfluoroelastmor (FEP) or Kalrez, Thermoflon Pascal (inside)
Liquid Supply Pump	Diaphragm pump, maximum flow rate 750cm ³ /min
Liquid Supply Pump Material	Tetrafluoroethylene, polyvinylidene fluoride
Flow Cell	Quartz glass
Required power supply	115 or 230 VAC as ordered, 200 VA
Dimensions & weight	W390mmxD520mmxH430mm, 18kg
Operating Environment	Temperature: 10 to 30°C, Humidity: 20 to 80 % (no condensation)

Note 3: USB cable (2 m) supplied as standard

Batch Cell: SALD-BC23

Cell Material	Quartz glass
Required Liquid Volume	Approx. 12 cm ³
Stirrer Mechanism	Up-and-down movement of blade
Dimensions & weight	W100mmxD120mmxH140mm, 0.8kg
Operating Environment	Temperature: 10 to 30°C, Humidity: 20 to 80 % (no condensation)

High-concentration Sample Measurement System: SALD-HC23S

Cell Material	Borosilicate glass
Required Liquid Volume	Approx. 0.15 cm ³
Dimensions & weight	W20mmxD100mmxH9mm, 0.2kg
Operating Environment	Temperature: 10 to 30°C, Humidity: 20 to 80 % (no condensation)

Cyclone Injection Type Dry Measurement Unit: SALD-DS55

Sample suction types	Cyclone type / One shot type / Hand shot type
Suction nozzle	Can be selected from 4 types

Sampling Unit Specifications

System	Cyclone type
Communication method	USB (PC control)
Required power supply	115/230VAC(±10%), 100VA, 50/60Hz (excluding dust collector and compressor)
Dimensions & weight	W 240xD 310xH 210 mm, 10 kg
Operating Environment	Temperature: 10 to 30°C, Humidity: 20 to 80 % (no condensation)

Pressure Regulator Specifications

Primary pressure	0.6 to 0.8 MPa
Secondary pressure	0.05 to 0.5 MPa
Filtration rating	Removing particles of 5 µm or larger
Connection to air source	Tube of 6 mm outside diameter
Communication method	USB (PC control)
Required power supply	115/230VAC(±10%), 100VA, 50/60Hz (excluding dust collector and compressor)
Dimensions & weight	W 130xD 223xH 233 mm, 3 kg
Operating Environment	Temperature: 10 to 30°C, Humidity: 20 to 80 % (no condensation)

Requirements for compressor and dust collector

Compressor	Output : 0.4 kW Minimum pressure : Approx. 7 kgf/cm ² (approx. 0.69 MPa) Air discharge : 45 L/min Tank volume : Approx. 30 L
Dust collector	Type : Vacuum cleaner (Paper pack type) Dust collecting efficiency : More than 99% for 0.3 µm particles Capacity : 2.0 m ³ /min or more Vacuum : Approx. 2000 mm Aq or lower Suction hose diameter : Approx. 32 mm

Software Specifications

WingSALD II

Measurement and Data Display Functions	
Measurement of Particle Size Distribution	Allows measurements using measurement assistant function (interactive process based on SOP)
Refractive Index Setting	Automatic refractive index calculation function (LDR method: Light Intensity Distribution Reproduction Method) makes setting the refractive index easy.
Real-Time Display	Particle size distribution/light intensity distribution simultaneous display
Diagnostics/Adjustments	Self-diagnostic function and cell check function
Recalculation of Particle Size Distribution	Batch recalculation of max. 200 distributions
Display of Particle Size Distribution Data	Displays overlay of max. 200 distributions
Display of Light Intensity Distribution	Displays overlay of max. 200 distributions
Statistical Data Processing	Max. 200 sets of data (also allows overlaying max. 200 data sets)
Time-Series Processing	Max. 200 sets of data
3-Dimensional Graphing	Max. 200 sets of data
Data Transfer via Clipboard	[Image Output]: Outputs entire data sheet or graph only. [Text Output]: Outputs summary data, particle size distribution data, or light intensity distribution data.
Data Sorting	Sorts by file name, sample ID, sample number, or refractive index
Output Conditions	
Particle Size (µm) Divisions	Fixed 51 or 101 divisions User settable 51 divisions
Particle Amount (%) Divisions	Fixed 51 divisions User settable 51 divisions
Distribution Basis	Count, length, area, or volume
Expression of Cumulative Distribution	Oversized or undersized
Expression of Frequency Distribution	q, q / Δx, q / Δlog x
Smoothing Levels	10 levels
Distribution Function Fitting	Rosin-Rammler distribution, logarithmic Gaussian distribution
Data Shifting	±10 levels
Report Function	Single data sets (6 templates), overlaid data (5 templates), statistical data, time-series data, or 3D data can be selected and output using batch processing
Data Analysis Functions	
Scattering Angle Evaluation Function	Evaluates scattering characteristics within micro angle regions for samples such as optical films and sheets.
Data Emulation Functions	Emulates measurement results from other instruments and measurement principles, using SALD series measurement results.
Mixture Data Simulation Function	Simulates particle size distributions using any mixture ratio of multiple particle size distributions.
Data Connection Function	Combines two particle size distributions with different measurement ranges at any particle size point to create a single particle size distribution.
Continuous Measurement Function	Continuously measures changes in particle size distributions and particle diameters over time, at intervals as short as one second, and saves the results.

Note 4: The LDR method automatically calculates an appropriate refractive index based on consistency between the actual measured light intensity distribution and one reproduced (recalculated) from particle size distribution data. This method was developed by Shimadzu and published in two technical papers. It is sometimes called the "Kinoshita Method", in academic communities, after the name of Shimadzu's engineer.

PC Requirements

The software is included standard on a CD-R with the SALD system (optical system). Install the software on a PC that meets the following specifications.

OS	Windows 10 (32/64bit)	
CPU	Core i5, i7	
MEMORY	4GB min.	
HDD	Min. 1 GB of free space required.	
CD-ROM Drive	Required for software installation	
USB Port	Unit Name	Required USB port
	SALD-2300	1 port
	SALD-BC23	0
	SALD-MS23	1 port
	SALD-HC23S	0
	SALD-DS55	2 ports
Printer	Printer	1 port
	Display	SXGA (1280×1024 pixels) min.
Printer	Must be compatible with operating system.	

*1: Windows is a registered trademark of Microsoft Corporation in the United States and other countries.

*2: Other company names and product names mentioned in this document are registered trademarks or trademarks of their respective companies.

*3: The TM and ® symbols are omitted in this document.

Particle Size Analyzer Applications

Particle size distribution is one of the main factors determining the characteristics of powders and particles.

Powders and particles are used in a wide variety of fields for a wide range of objectives and applications. In some cases, they are used directly as pharmaceuticals, catalysts, additives, or binders while in other situations they are used as raw ingredients. In either case, the particle size distribution can have a major effect on the characteristics desired for a given application or objective, or on the performance and quality of a final product. Consequently, measuring the particle size distribution is essential for stabilizing or improving the characteristics, performance, or quality of powders or particles.

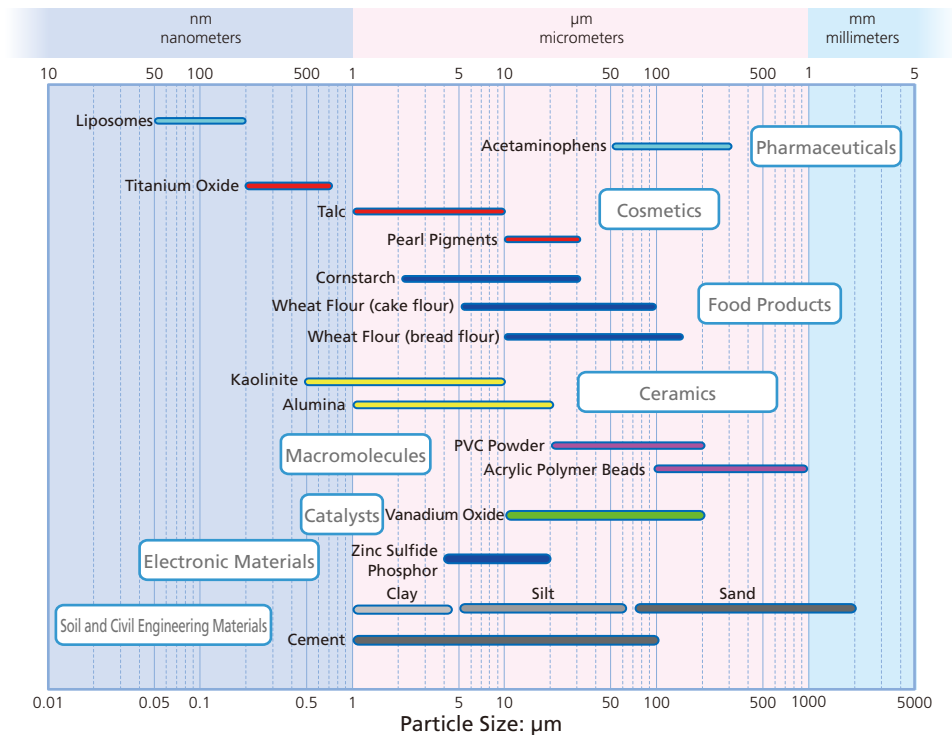

Shimadzu particle size analyzers are used in a wide variety of fields, for a wide range of purposes and applications.

- 1 Pharmaceuticals** The smaller the particles, the larger their specific surface area and the more quickly they dissolve. In the case of particles in medical injections, the particle size determines how they pass through or penetrate capillaries and blood vessel walls and which parts of the body they reach. This has a major influence on the efficacy and side effects of pharmaceuticals.
- 2 Cosmetics** For lipstick, mascara, and eye shadow, subtle differences in color and shine are controlled by differences in the particle size distribution. The smoothness or UV light-blocking properties of creams also vary depending on the particle size distribution.
- 3 Food Products** Many food products include powdered ingredients. The mouth, tooth, and tongue feel and other characteristics of bread, cakes, pasta, etc. depend on the particle size distribution. Also, controlling the particle size distribution in beverages is important to ensure consistent quality. For example, smaller particle sizes are used in milk and lactic acid beverages to prevent differences in concentration and taste between the upper and lower portions of the container
- 4 Ceramics** The strength, density, hardness, heat resistance, water and air permeability, and other characteristics of ceramics depend not only on the type of ingredient particles, but also significantly on the particle size distribution.
- 5 Macromolecules** When particles are used as ingredients in pipes, films, and sheets, the particle size distribution can affect the strength and light permeability of the final product.
- 6 Catalysts** Though chemical reactivity is affected by the specific surface area and pore structure, given the same material, the chemical reactivity can be controlled by varying the particle size distribution.
- 7 Electronic Materials** The manner and degree to which particle size affects electronic materials differ depending on the application and material. However, the quality control of particle size distribution is increasingly being required to ensure higher and more consistent quality of the final product.
- 8 Soil and Civil Engineering Materials** The particle size distribution of soil and cement has a significant effect on the stability and strength of supporting ground, the strength of buildings and other structures, and how much these change over time. Also, measuring the particle size distribution is an important factor in understanding the scale of environmental pollution in soil.

Measurement Technology Laser Diffraction Method

- There is a one-to-one correspondence between the particle diameter and the light intensity distribution pattern.

When a particle is irradiated with a laser beam, light is emitted from the particle in every direction. This is "scattered light". The intensity of the scattered light varies with the scattering angle and describes a spatial intensity distribution pattern. This is a "light intensity distribution pattern". If the particle diameter is large, the scattered light emitted from the particle is concentrated in the forward direction (i.e., the direction of the laser beam), and fluctuates intensely in an angular range too small to be represented in a diagram. Compared to the light emitted in the forward direction, the intensity of all other light is extremely low. As the particle diameter becomes smaller, the pattern of the scattered light spreads outwards. As the particle becomes even smaller, the intensity of the light emitted to the side and backwards becomes higher. The light intensity distribution pattern becomes gourd-shaped and spreads out in every direction. In this way, then, there exists a one-to-one correspondence between the particle diameter and the light intensity distribution pattern. This means that the particle diameter can be ascertained by detecting the light intensity distribution pattern.

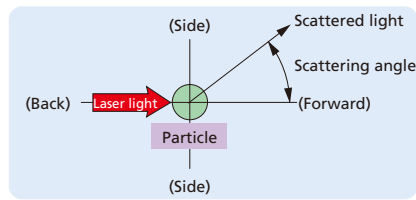

Diffraction/Scattering by Particle

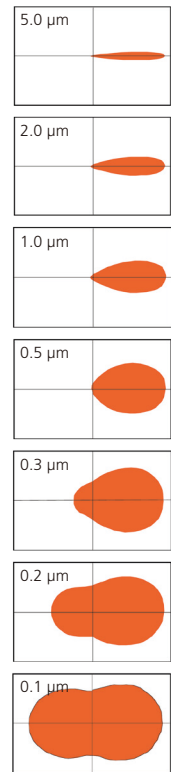

Correspondence between the particle diameter and the light intensity distribution pattern.

- Measurement is performed on particle groups.

Particle size distribution measurement is not performed on individual particles, but rather on particle groups made up of large numbers of particles. Particle groups contain particles of different sizes, and the light intensity distribution pattern emitted by a group is composed of all the scattered light emitted from all the individual particles. The particle size distribution, in other words, what particle sizes are present in what proportions, can be obtained by detecting and analyzing this light intensity distribution pattern. This is the basic principle behind the laser diffraction method used in laser diffraction particle size analyzers.

- Optical System in SALD-2300

The laser beam emitted from the light source (semiconductor laser) is converted into a thick beam with a collimator and this is directed at the particle group. The scattered light emitted from the group in a forward direction is concentrated with a lens, and concentric scattering images are formed at a detecting plane positioned at a distance equal to the focal length. This is detected with the wing sensor in which light-receiving elements are arranged concentrically. The scattered light emitted to the side and backwards is detected with side and back scattered light sensors. The light intensity distribution data can be obtained by detecting scattered light data of all directions.

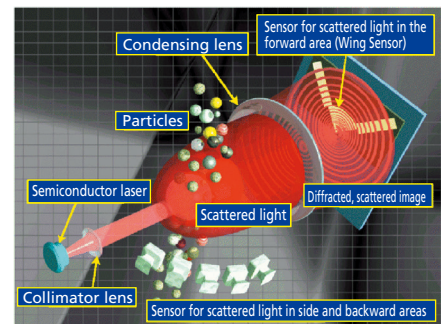

- Flow of Light Intensity Detection and Data Processing

With the SALD-2300 laser diffraction particle size analyzer, particle size distributions are calculated using light intensity distribution data.

The overall flow of detection and data processing is shown in the diagram to the left. In measurement, the whole range of operations from the detection of scattered light intensity distribution patterns to the calculation of the particle size distribution is executed as one process, and the particle size distribution data is output.

Recalculation of particle size distributions can be performed by using the previously detected and saved light intensity distribution data and selecting a refractive index that is different from the time of measurement.

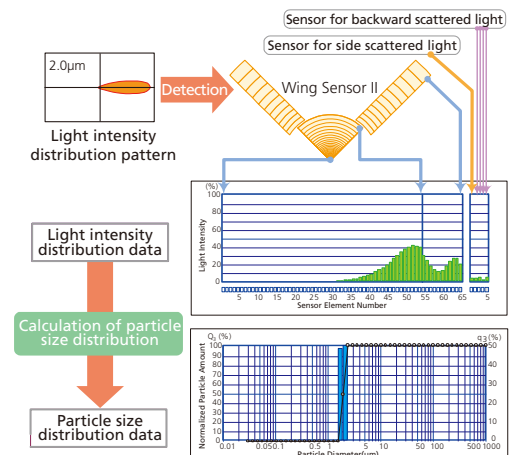



Shimadzu Corporation

www.shimadzu.com/an/

For Research Use Only. Not for use in diagnostic procedures.

This publication may contain references to products that are not available in your country. Please contact us to check the availability of these products in your country.

Company names, products/service names and logos used in this publication are trademarks and trade names of Shimadzu Corporation, its subsidiaries or its affiliates, whether or not they are used with trademark symbol "TM" or "®".

Third-party trademarks and trade names may be used in this publication to refer to either the entities or their products/services, whether or not they are used with trademark symbol "TM" or "®".

Shimadzu disclaims any proprietary interest in trademarks and trade names other than its own.

The contents of this publication are provided to you "as is" without warranty of any kind, and are subject to change without notice. Shimadzu does not assume any responsibility or liability for any damage, whether direct or indirect, relating to the use of this publication.