

Genius 1025

Nitrogen & air generator for PerkinElmer Instruments



Your local **gas generation** partner

Description

Producing a single output of LC-MS grade nitrogen (up to 15 L/min) and air (up to 35 L/min) specifically to meet the requirements of PerkinElmer's QSight Triple Quad 110 and 210 LC-MS/MS systems, the Genius 1025 has been designed using membrane technology to produce LC-MS grade purity and an internal air dryer to produce a clean supply of dry air.

The Genius 10 series models are compressor-based systems Peak manufacture utilizing membrane technology to ensure high performance and supply of analytical instrument grade nitrogen.



Applications

- 1 x PerkinElmer QSight Triple Quad 110
- 1 x PerkinElmer QSight Triple Quad 210

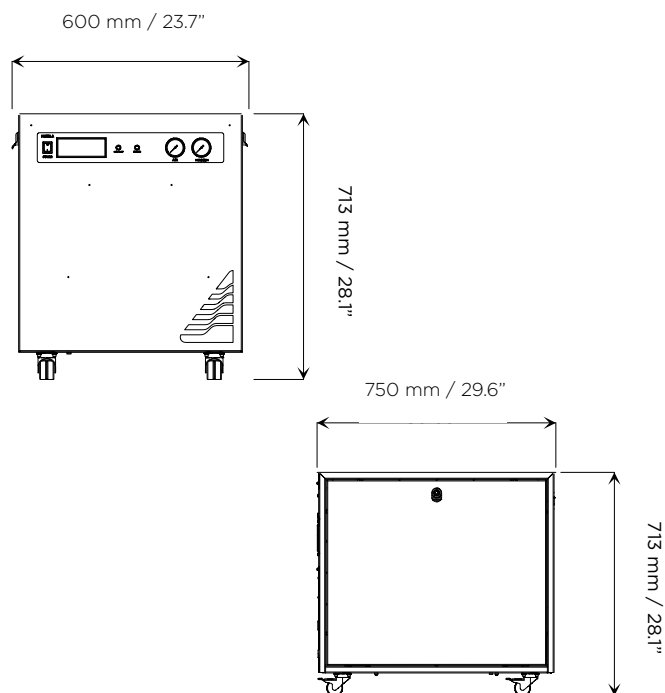

Key Features

- Self-contained solution with integrated compressors, no need for an external air supply
- Highly economical source of nitrogen/dry air with low lifetime running costs
- Easy to use, gas at the push of a button
- Wheels make it easy to manoeuvre generator around the lab
- 12 month comprehensive on-site warranty

Technical Specifications

Genius 1025

Max Flow	Up to 15 L/min Nitrogen & up to 35L/min Dry Air
Min/ Max Pressure	Up to 80 psi Nitrogen & up to 110 psi Dry Air
Gas outlets	2 x 1/4" BSPP
Max Relative Humidity	80% Non-Condensing
Max Altitude	2000m
Particles	<0.01µm
Phthalates	NONE
Suspended liquids	NONE
Operating Temperature	5°C (41°F) to 30°C (86°F)
Electrical Requirements	230V±10% 50 / 60 Hz 5A
Power Consumption	<1,265VA
Heat Output	3,925 BTU /Hr
Generator Dimensions (H x W x D)	713 x 600 x 750 mm 28.1 x 23.7 x 29.6"
Generator Weight	108.5 kg / 239.3 lbs
Shipping Weight	137 kg / 302.1 lbs

Ordering Information

Part Number	3301714
Annual Service	visit: www.peakscientific.com/ordering
Complete Maintenance Plan	

† Noise level expressed as SPL (Sound Pressure Level) measured at 1m from source in a reverberant chamber

[PEAK Protected]™

Peak Scientific gas generators define the benchmark in reliability, convenience and performance in laboratories around the world, and come backed by a 12 month warranty. Beyond this period however you can ensure that your investment continues to be **[Protected]** by our comprehensive generator care cover.

Our world-class aftercare support packages deliver a program of scheduled preventative maintenance whilst giving you the reassurance of instant access to worldwide technical support and priority on-site response in the untimely event of a breakdown.

Peak Scientific UK
Tel: +44 (0)141 812 8100
Fax: +44 (0)141 812 8200

Peak Scientific North America
Tel: +1 866 647 1649
Fax: +1 978 608 9503

For a full list of our worldwide office locations, please visit: www.peakscientific.com/offices

Web: www.peakscientific.com
Email: discover@peakscientific.com

Peak Scientific's Quality Management System conforms to:
ISO 9001:2015



Product Certifications

